

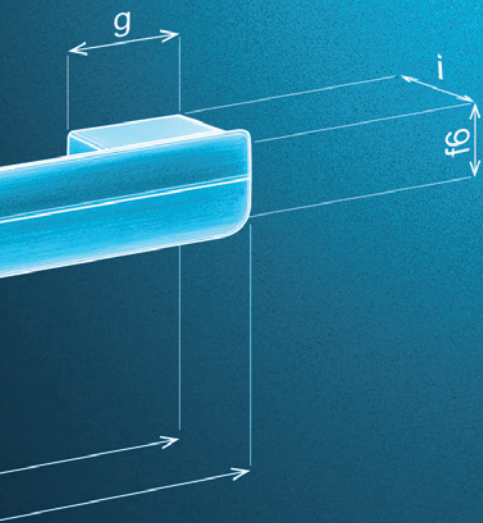

handles, handle profiles, hooks



SEPARATE CATALOGUE

For a complete overview with examples of interior handles, see the separate design catalogue of Tulip handles. Use it when making selection with the customer.



3D MODELS FOR FURNITURE PLANNING SOFTWARE

All handles are prepared in 3D for planning programs. You can download them on our portal demos24plus.com.



SAMPLE ROOM DISPLAYS

The best way to choose the handles is to see them in person. We have them on display in our sample rooms so that the prospective buyer can attach them to the chosen door decor.



PORTAL

A customer portal for purchasing, order overview, job submission, formatting, and status tracking. All in one place: stock availability, your prices, and much more.



ADVISORY SERVICE

Not sure how to choose or assemble the fittings? Call +420 596 223 455 or email export@demos-trade.com and we will be happy to help you.



DELIVERY TO YOUR DOOR

All orders will be delivered to your hands within 72 hours.



contents

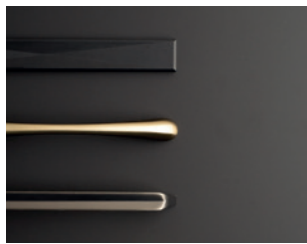
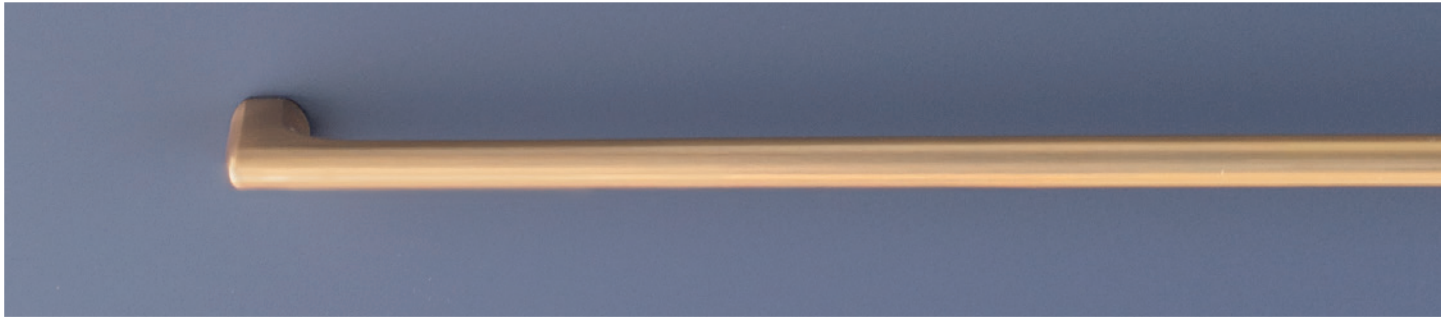

**metal handles
and knobs**

Tulip	11.15
Marella	11.77
Hettich	11.85

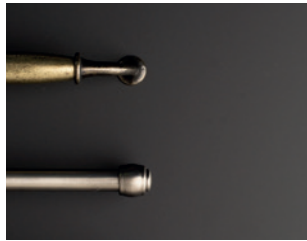

**rustic
and porcelain**

Tulip	11.38
Marella	11.80



**recessed
handles
and profiles**

Tulip	11.45
Hettich	11.89
Marella	11.84

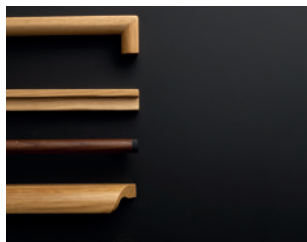

**wooden
and leather**

Tulip	11.61
-------	-------

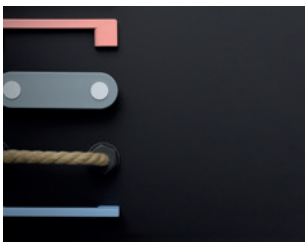
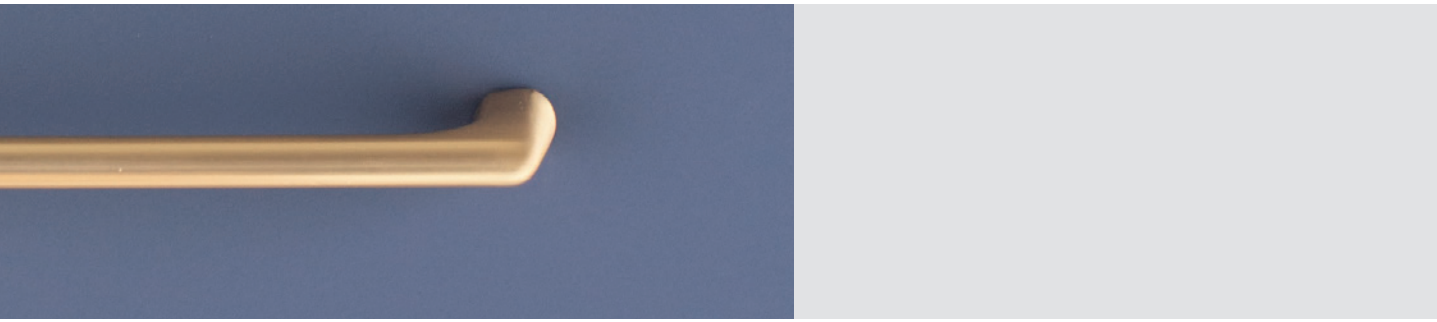

**children's
and plastic**

Tulip	11.66
-------	-------

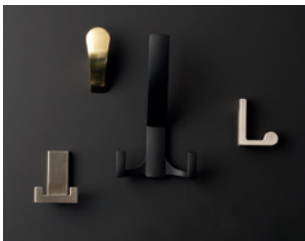

hooks

Tulip	11.69
-------	-------



**handles, knobs,
hooks**

Marella	11.77
Hettich	11.85

Abbreviations for materials used:

[Zn]	[Alu]	[Fe]	[Zamac]	[Stainless steel]	[PWC]	[L]
zinc	aluminium	steel	zamac	stainless steel	polypropylene wood-fibre cellulose	leather

overview of colours

Overview of colours of handles and hooks



chrome



antique gold

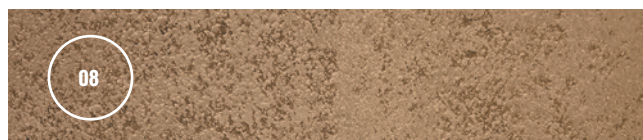

stainless steel

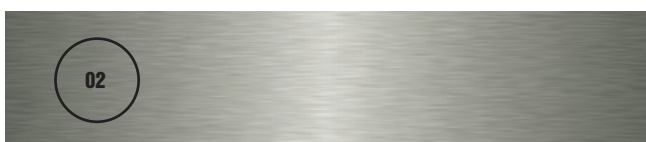

bronze

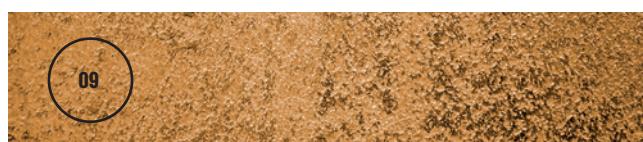

stainless steel imitation



antique bronze

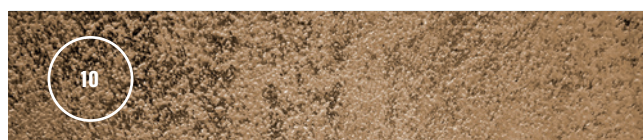

nickel

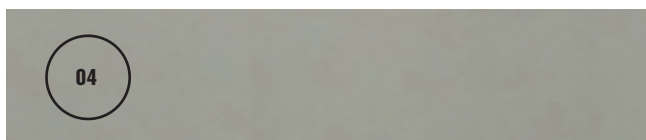

copper



black nickel



antique copper



anodised aluminium



silver



gold



pewter



📌 Handles have various surface treatments: brushed, polished, matt. The individual colours and decors of handles may vary slightly in shade between different models.

overview of colours

antique pewter



anthracite



black



antique black

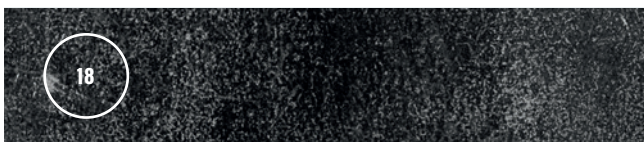

brown

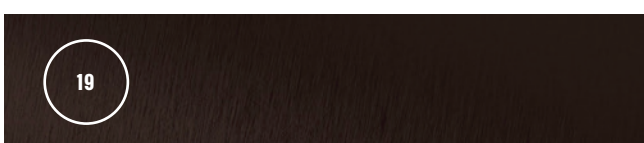

white

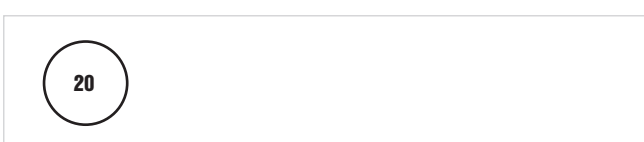

wood



plastic



porcelain



leather

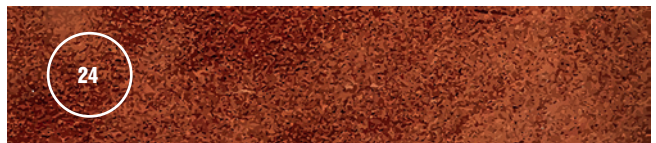

dark gold



champagne gold

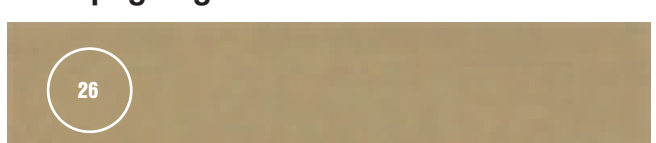

coffee



champagne bronze

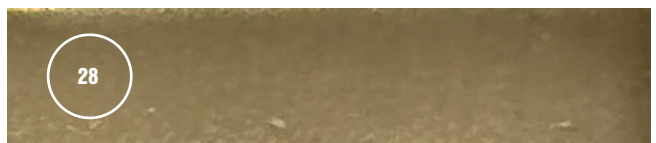

titanium

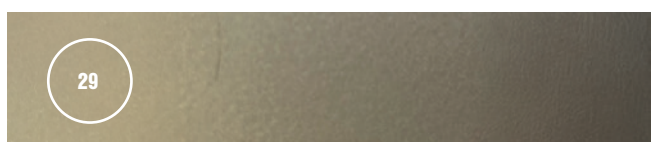

steel grey

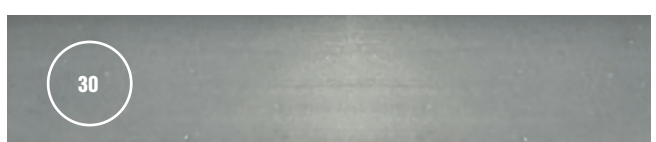

concrete

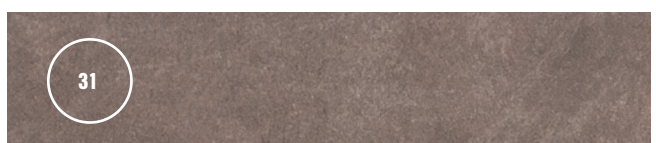

earth

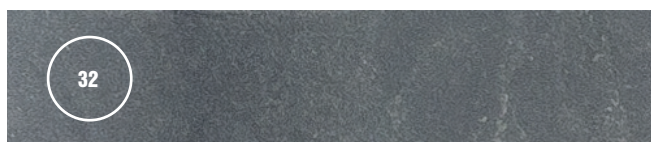

overview of handles and hooks

Overview
of handles
and hooks



			
Tonk 11.15	Iris 11.17	Boise 11.19	Nakana 11.21
			
Scala 11.15	Oga 11.17	Joliet 11.19	Luca 11.21
			
Scoop 11.15	Muta 11.17	Lenox 11.19	Ulica 11.21
			
Peblo 11.15	Peca 11.17	Cory 11.19	Menusa 11.21
			
Wake 11.16	Recife 11.18	Mount 11.19	Rocata 11.22
			
Asama 11.16	Palm 11.18	Resina 11.20	Sosa 11.22
			
Umberto 11.16	Recife II 11.18	Davide 11.20	Bastone 11.22
			
Marca 11.16	Enuca 11.18	Marina 11.20	Lacata 11.22
			
Cub 11.16	Mella 11.18	Penka 11.20	Ida 11.23

overview of handles and hooks



Kira 11.23



Hrazda 11.24



Porta 11.24



Wakano 11.25



Jakoto 11.25



Likano 11.25



Hytech 11.25



Zuzana 11.25



Napa 11.26



Isola 11.26



Yuma 11.26



Acri 11.26



Envel 11.26



Sulky 11.27



Kentucky 11.27



Kink 11.27



Halti 11.27



Andrea 11.27



Besina 11.27



Nomina 11.28



Ruona 11.28



Piombina 11.28



Iluna 11.28



Beta 11.29



Anita 11.29



Uroso 11.29



Unesa 11.30



Palin 11.30



Vali 11.30



Sema 11.30



Kewina 11.31



Pelena 11.31



Malada 11.31



Sakita 11.31



Geneda 11.31



Fiona 11.31



Ruota 11.32



Kutta 11.32



Ruota 11.32



Enza 11.32



Kutta 11.32



Enza 11.32













Blink 11.33



Tonk 11.33



overview of handles and hooks

	Mesa	11.33		Evan	11.35		Tinto	11.37		Victoria	11.38
	Envel	11.33		Koby	11.35		Kentucky	11.37		Turia	11.39
	Kink	11.33		Marusa	11.35		Peca	11.37		Rustik	11.39
	Bella	11.33		Galka	11.35		Prisma	11.37		Country	11.39
	Conic	11.34		Tomic	11.36		Frame	11.37		Turia	11.39
	Mella	11.34		Boise T	11.36	Rustic				Rustik	11.39
	Andrea	11.34		Peblo	11.36		Menfi	11.38		Country	11.39
	Iroko	11.34		Boise O	11.36		Tomo	11.38		Gipa	11.40
	Ota	11.34		Joliet	11.36		Victoria	11.38		Sara	11.40
	Ruza	11.34		Recife II	11.36		Menfi	11.38		Margarita	11.40
	Jota	11.35		Hrazda	11.37		Tomo	11.38		Gipa	11.40

overview of handles and hooks



Sara 11.40



Margarita 11.41



Vintage 11.41



Serena 11.41



Vintage 11.41



Serena 11.41



Corsica 11.42



Cona 11.42



Loka 11.42



Bold 11.42



Kaniva 11.43



Panel F 11.43



Ring F 11.43



Avoca 11.44



Shellby 11.44



Misura 11.44



Anetta 11.44



Nave 11.44



Carpi 11.44



Gliss 11.45



Madrid 11.45



Rapid 11.45



Dunk 11.45



Rulida 11.45



Orinoco 11.45



Pesara 11.46



Malena 11.46



Concava 11.46



Lori II 11.47



Nary 11.47



Bowie 11.48



Lucata 11.48



Sophia 11.49

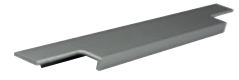

Ramara 11.49



Tende 11.50



Zoid 11.50



Juvio 11.51

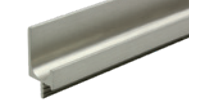

Juvio L 11.51

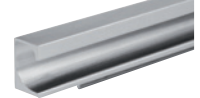

Paolo 11.51

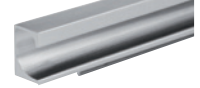

Paolo L 11.51

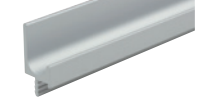

Fano 11.52

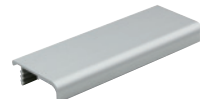

Lungo 11.52

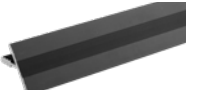





Ria 11.52

overview of handles and hooks







Wooden and leather

-  Berga 11.61
-  Metra 11.61
-  Boise 11.61
-  Lynn 11.61
-  Beam 11.61
-  Rail 11.61
-  Mewo 11.62
-  Xin 11.62
-  Lines 11.62
-  Mewo 11.62

-  Vasca 11.62
-  Tine 11.63
-  Wave 11.63
-  Ames 11.63
-  Chico 11.63
-  Moku 11.63
-  Ames 11.63
-  Square 11.64
-  Taper 11.64
-  Jacek 11.64
-  Hole 11.64

-  Jura 11.64
-  Adam 11.65
-  Bala 11.65
-  Sola 11.65

Children's

-  Cute 11.66
-  P431 11.66
-  Spaccata 11.66
-  Cute 11.66
-  P439 11.66
-  Spaccata 11.66

-  Cana 11.67
-  Palla 11.67
-  Funga 11.67
-  Bottone 11.67
-  Large 11.68
-  Into 11.68
-  Filip 11.69

Hooks

-  Balo 11.69
-  Troy 11.69
-  Element 11.69

overview of handles and hooks

	Rudi	11.69		Kara M	11.71		Cid XL	11.73		Orio	11.75
	Boise	11.69		Marell	11.71		Marcel XL	11.73		Murero XL	11.75
	Doris	11.70		Gant	11.72		Lugo XL	11.73		Rubico XL	11.75
	Rini	11.70		Dax	11.72		Muso	11.74		Orio XL	11.75
	Peri	11.70		Ener	11.72		Livorno	11.74		Balo XL	11.76
	Dyan	11.70		Gant XL	11.72		Darec	11.74		Xin	11.76
	Rini XL	11.70		Iwo	11.72		Lerico	11.74		Twist	11.76
	Peri XL	11.70		Ener XL	11.72		Rokos	11.74		Extendo XL	11.76
	Pera	11.71		Cid	11.73		Darec XL	11.74			
	Kara S	11.71		Marcel	11.73		Murero	11.75			
	Kara L	11.71		Lugo	11.73		Rubico	11.75			

overview of handles and hooks

Marella



Vitruvio 11.77



Lama 11.77



Tonda 11.77



Torus 11.78



Linæ 11.79



Torus 11.78



Riva 11.78



Riva 11.78



Brera 11.79



Defense 11.79



Art Decó 11.80



Viaggio 11.80



Viaggio 11.80



Sirius 11.81



Columnnae 11.81



Macis 11.81



Columnnae 11.81



Macis 11.81



Augusto 11.82



Smarty 11.82



Aramis S 11.82



Tiberio 11.82



Jonathan 11.82



Aramis M 11.82

Hettich



Anzio 11.85



Bermeo 11.85



Intra 11.85



Salacia 11.86



Chalcis 11.86



Baldone 11.86



Naila 11.86



Catana 11.87



Salona 11.87



Balmo 11.87



Vantania 11.87



Egara 11.87



Genoa 11.87



Fermo 11.88



Coria 11.88



Monacum 11.88



Messana 11.88



Haida 11.88

overview of handles and hooks

- 

Almus 11.88
- 

Gela 11.89
- 

Gela a Galati 11.89
- 

Empoli 11.89
- 

Galati 11.89
- 

Aboa 11.89
- 

Narni 11.89
- 

Nidum 11.90
- 

Touch - in 11.90
- 

Touch - in 11.90

metal handles and knobs

Tonk [Zamac]

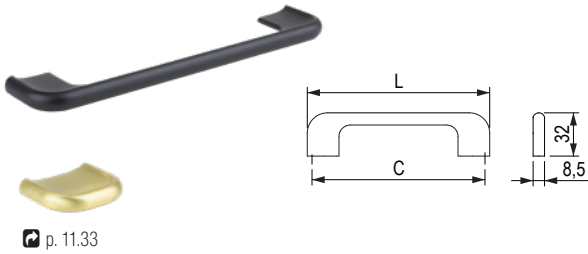

p. 11.33

brushed nickel	black matt	brushed gold	drilling pitch C (mm)	length L (mm)
489337	489336	489338	160	135
489340	489339	489341	320	167

Scoop [Zamac]

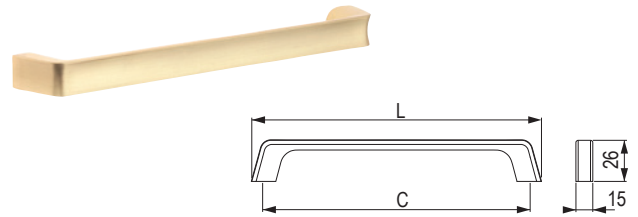

matt gold	matt copper	drilling pitch C (mm)	length L (mm)
351843	351845	160	180
351844	351846	320	340

Scala [Alu]

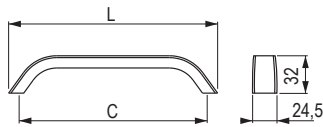

brown matt	anodised aluminium	stainless steel imitation	brushed black	drilling pitch C (mm)	length L (mm)
×	227248	227239	544812	128	147
261978	227249	227240	378651	160	179
261979	227250	227242	378652	192	211
261980	227251	227243	378653	224	243
261981	227252	227244	378654	320	339
×	×	227245	378655	448	467
×	×	227246	378656	544	563
×	×	227247	378657	640	659

Peblo [PWC]

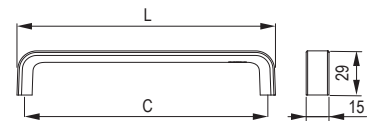

earth	concrete	drilling pitch C (mm)	length L (mm)
543774	543773	160	170

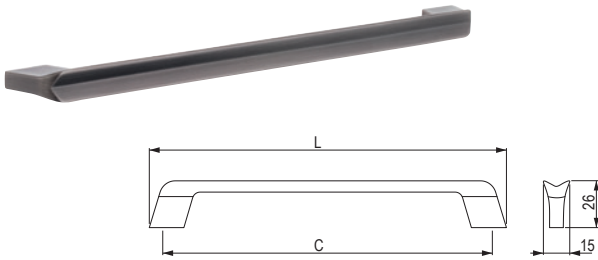

Wake [Zamac]



	drilling pitch C (mm)	length L (mm)
401562	160	180
401563	320	340

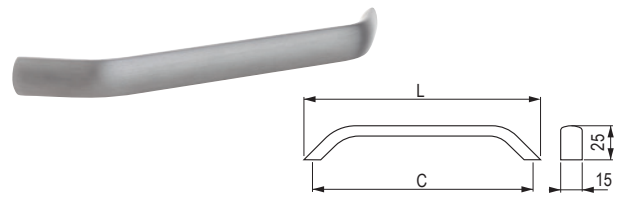

Marca [Alu]



		drilling pitch C (mm)	length L (mm)
225008	544813	160	197
225009	544814	192	229
225010	544815	224	261
225011	544816	320	357
225012	544817	448	485

Asama [Zn]



			drilling pitch C (mm)	length L (mm)	width D (mm)	height H (mm)
157231	157234	157228	160	204	17	26
157232	157235	157229	192	245	18	29

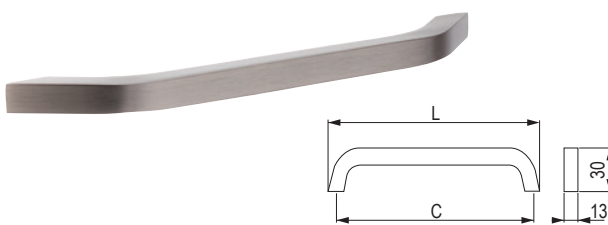

Umberto [Zamac]



	drilling pitch C (mm)	length L (mm)
192369	192	214
192370	256	278
192371	320	345
192372	448	470

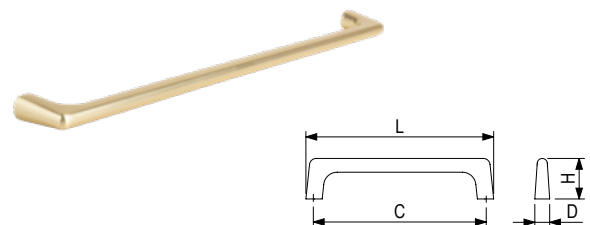

Cub [Zn]



			drilling pitch C (mm)	length L (mm)	width D (mm)	height H (mm)
494759	494758	494760	128	139	11	30
494762	494761	494763	192	203	11,8	31,3
494765	494764	494766	320	335	13,7	31,8

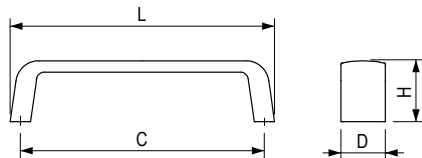

Iris [Alu]



		drilling pitch C (mm)	length L (mm)	width D (mm)	height H (mm)
308974	544818	96	104	14	18,7
308975	544819	128	136	17	22,3
308976	544820	160	168	17,6	22,6
308977	544821	192	200	18,1	23,6

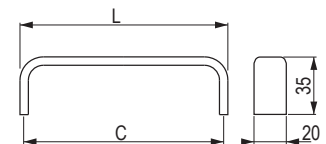

Muta [Alu]

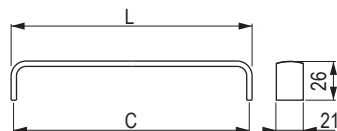

		drilling pitch C (mm)	length L (mm)
36821	36829	128	136
36822	36830	160	168
36823	36831	192	200
36824	36832	224	232
36825	36833	320	328
36826	36834	448	456

Oga [Zn]





		drilling pitch C (mm)	length L (mm)
157203	157199	96	102
157204	157200	128	134
157205	157201	160	166
157206	157202	192	198

Peca [Zn]



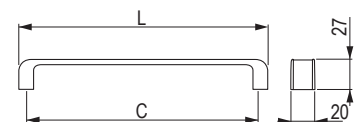

p. 11.37



		drilling pitch C (mm)	length L (mm)
225070	227260	128	142
225071	227261	192	206
225072	225066	256	270

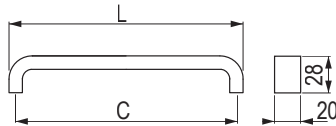

Recife [Zamac]

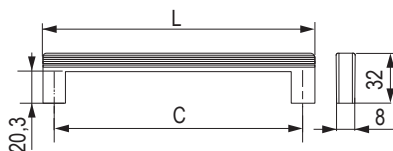

	drilling pitch C (mm)	length L (mm)
157638	128	137
157639	192	201
157640	224	233
157641	256	265
157642	320	329
157643	448	457

Palm [Zamac]







			drilling pitch C (mm)	length L (mm)
547166	547164	547165	160	171

Recife II [Zamac]

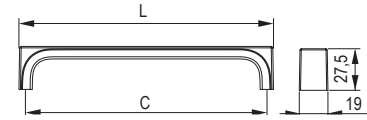



p. 11.36

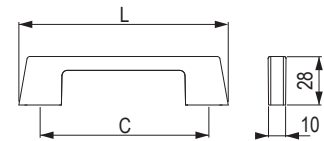

			drilling pitch C (mm)	length L (mm)
543780	543779	543778	160	169
543783	543782	543781	320	329

Enuca [Zn]



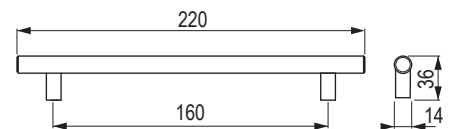

	drilling pitch C (mm)	length L (mm)
284096	128	143
284097	160	190
284098	224	254
284099	320	352

Mella [Alu]



p. 11.34

	
396165	396164

metal handles and knobs

Boise [Zamac]





p. 11.61



p. 11.36



p. 11.36

		drilling pitch C (mm)	length L (mm)
dark brushed gold	black matt		
544832	544831	160	210
546229	546228	320	370

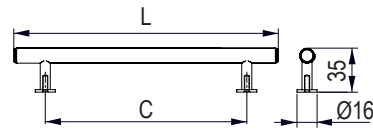



Joliet [Alu /zamac]



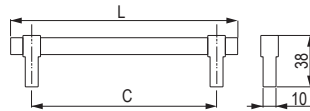

p. 11.36



		drilling pitch C (mm)	length L (mm)
champagne bronze	steel grey/black matt		
547167	547170	160	190
547168	547171	256	286
547169	547172	416	446

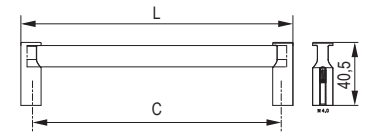

Cory [Alu]



		drilling pitch C (mm)	length L (mm)
lacquered oak / brushed black	brushed black		
543754	543759	160	175
543756	543757	320	335
543759	543755	1024	1039

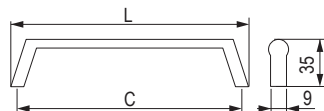

Lenox [Zamac]

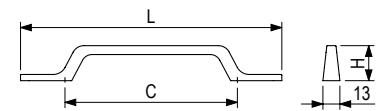

		drilling pitch C (mm)	length L (mm)
dark brushed gold	black matt		
547158	547161	160	175
547159	547162	224	239
547160	547163	320	335

Mount [Zn]



			drilling pitch C (mm)	length L (mm)	height H (mm)
brushed nickel	black matt	white matt			
494749	494750	494751	128	194	26
494752	494753	494754	192	258	27,2
494746	494747	494748	224	290	27,2

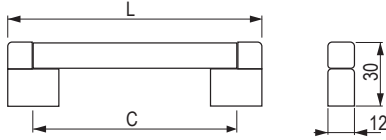

Resina [Zamac]



		drilling pitch C (mm)	length L (mm)
black matt			
500450		128	152
500451		160	184
500452		192	216
500453		224	248
500454		256	280
500455		320	344
500456		384	408
500457		448	472
500458		480	504
500459		672	696
500460		736	760
500461		832	856
399520		960	984
500462		1056	1080
399522		1184	1208

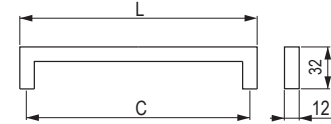

Marina [Stainless steel]

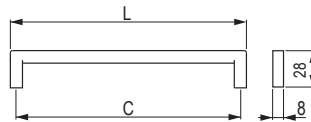

			
brushed stainless steel	black matt	drilling pitch C (mm)	length L (mm)
203829	494687	128	140
203822	494680	160	172
203823	494681	192	204
203824	494682	224	236
203825	494683	320	332
203826	494684	480	492
203827	494685	640	652
203828	494686	736	748

Davide [Zamac]







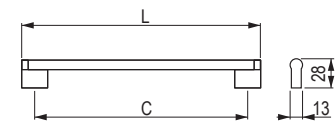

			
brushed nickel	matt chrome	drilling pitch C (mm)	length L (mm)
343940	343951	96	104
343941	343952	128	136
343942	343953	160	168
343943	343954	192	200
343944	343955	224	232
343945	343957	320	328

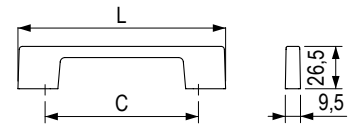
Penka [Zamac]





			
brushed nickel	drilling pitch C (mm)	length L (mm)	
157250	128	136	
157251	160	168	
157252	192	200	
157253	224	232	
157255	320	328	
157256	448	456	

Nakana ^[Alu]

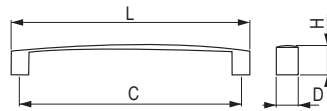
						drilling pitch C (mm)	length L (mm)
white polished	black polished	black matt	matt chrome	brushed nickel	polished chrome	96	129
502023	502029	502035	502041	502047	502053	96	129
502024	502030	502036	502042	502048	502054	128	161
502025	502031	502037	502043	502049	502055	160	193
502026	502032	502038	502044	502050	502056	192	225
502027	502033	502039	502045	502051	502057	256	289
502028	502034	502040	502046	502052	502058	320	353



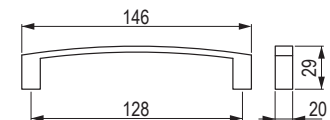

Luca ^[Zamac]

			drilling pitch C (mm)	length L (mm)	width D (mm)	height H (mm)
matt chrome	stainless steel imitation	antique gold	128	141	21	22
224941	224945	359879	128	141	21	22
224942	224946	359881	160	172	21,5	23

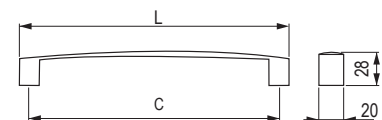
Menusa ^[Alu]

anodised aluminium

35971Ulica ^[Zamac]

				drilling pitch C (mm)	length L (mm)
brushed nickel	polished chrome	stainless steel imitation	matt chrome	128	146
355912	303317	289690	289696	128	146
355913	303318	289691	289697	160	178
355914	303319	289692	289698	192	210
355915	303320	289693	289699	256	274
355916	303321	289694	289700	320	338

Rocata [Alu]

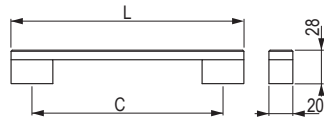

	drilling pitch C (mm)	length L (mm)
284104	160	203
284105	224	267
284106	320	363

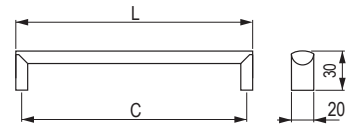

Lacata [Alu]



	drilling pitch C (mm)	length L (mm)
227223	128	138
227224	160	170
227225	224	234
227226	320	330
227227	448	458

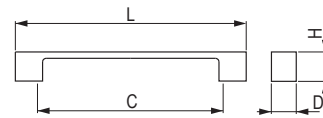

Sosa [Zn]

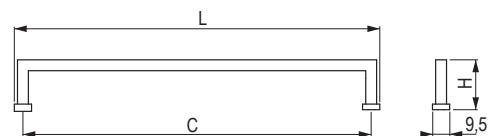

			drilling pitch C (mm)	length L (mm)	width D (mm)	height H (mm)
37031	37032	465322	160	190	20	24
37033	37034	465323	192	225	25	26

Bastone [Zamac]



		drilling pitch C (mm)	length L (mm)	height H (mm)
402388	402389	128	138	34
402391	402392	160	170	34
402453	402393	192	201,5	34
402394	402395	320	330	28

metal handles and knobs

Ida ^[Fe]

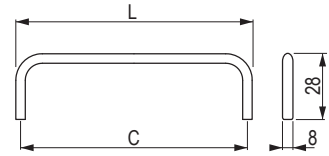

					drilling pitch C (mm)	length L (mm)
35341	157542	157543	494659	494625	96	112
157544	157545	157546	494660	494626	128	146
231423	231424	231422	494661	494627	160	170

Kira ^[Alu]

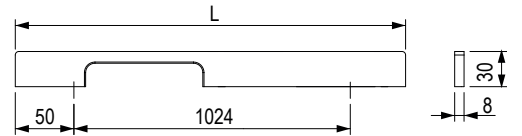
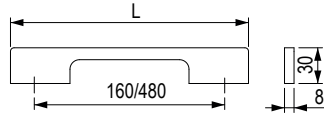
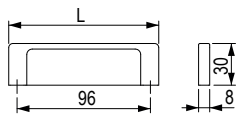
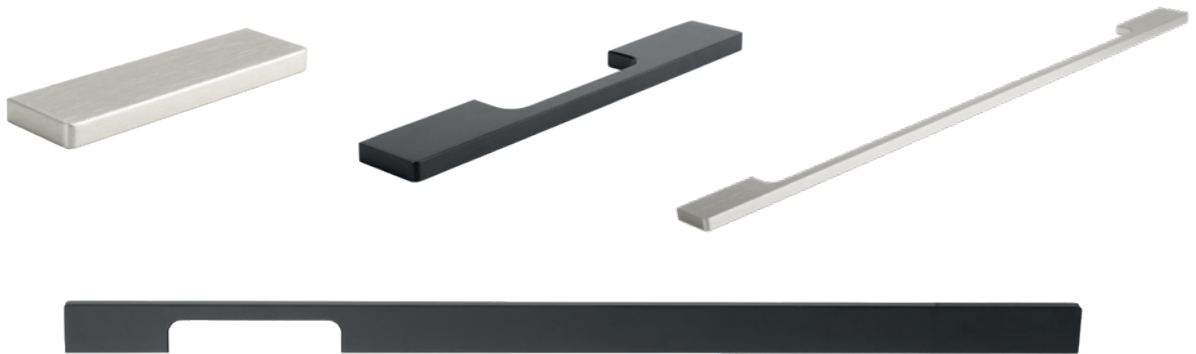





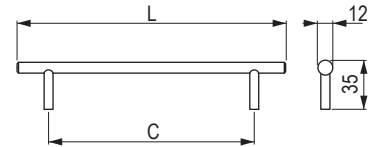

		drilling pitch C (mm)	length L (mm)
494416	494415	96	108
494418	494417	160	200
494420	494419	480	500
494422	494421	1024	1200

Hrazda [Fe/Alu]









p. 11.37

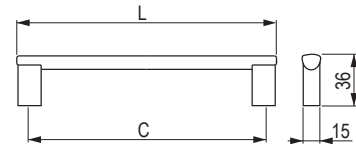

						drilling pitch C (mm)	length L (mm)
35941	35942	35943	35947	10640	494607	96	136
35921	35922	35923	35927	10641	494608	128	168
35661	35662	35663	35667	10642	494609	160	200
36731	36732	36733	36737	10643	494610	192	232
35931	35932	35933	35937	10644	494611	224	264
36741	36742	36743	36747	10645	494612	288	328
35651	35652	35653	35657	10646	494613	320	360
35951	35952	35953	35957	10648	494614	448	488
35641	35642	35643	35647	×	494615	544	584
36751	36752	36753	36757	10652	494616	672	712

Porta [Alu]



					drilling pitch C (mm)	length L (mm)
371989	37909	179439	157786	465922	96	108
371990	37880	37980	157787	465923	128	140
371991	37881	37981	157788	465924	160	172
371992	37882	37982	157789	465925	192	204
371993	37883	37983	157790	465927	224	236
371994	37884	37984	157791	465928	256	268
371995	37885	37985	157792	465929	288	300
371996	37886	37986	157793	465930	320	332
371997	37887	37987	157794	465938	384	396
371998	37888	179441	157795	465937	432	444
371999	37889	37989	157796	465931	448	460
372000	37890	37990	157797	465932	480	492
372001	37891	37991	157798	465933	544	556
389788	37893	37993	157800	465934	672	684
389789	37894	37994	157801	465935	736	748
389791	37895	37995	157802	465936	768	780

Wakano [Alu]

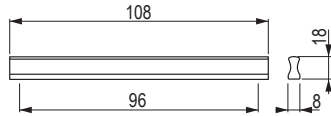
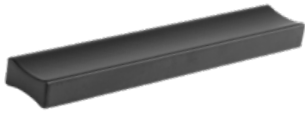

anodised aluminium

36333



black matt

494694

Hytech [Alu]

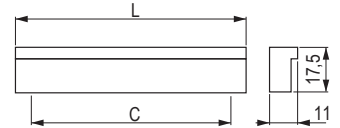

anodised aluminium

drilling pitch
C (mm)

length
L (mm)

190523

64

90

359390

96

120

359392

128

150

Jakoto II [Alu]

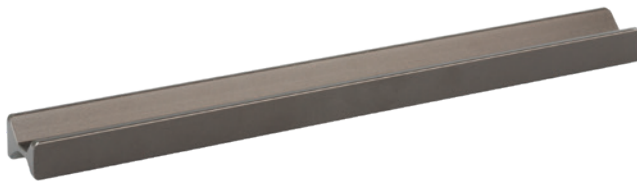

brushed coffee

544793



brushed steel
grey

544795



brushed
black

544789

drilling pitch
C (mm)

32

length
L (mm)

50

544794

544796

544790

128

150

x

x

544791

256

300

x

x

544792

1056

1200

Likano [Alu]

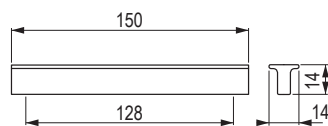

anodised aluminium

36332

Zuzana [Zamac]



anodised aluminium

drilling pitch
C (mm)

length
L (mm)

35900

32

44

35898

128

140

Napa [Zamac]

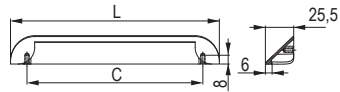

stainless steel imitation	black matt	drilling pitch C (mm)	length L (mm)
544826	544825	160	190

Acri [Zamac]

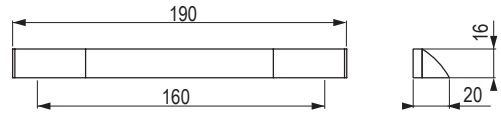

nickel brushed	black matt	black nickel polished	gold matt	white matt
398580	398581	398582	398583	398584

Isola [Alu]

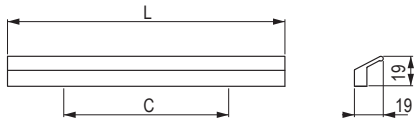

polished chrome	stainless steel imitation	anodised aluminium	drilling pitch C (mm)	length L (mm)
227293	227297	227301	96	116
227294	227298	227302	160	180
227295	227299	227303	224	244

Yuma [Zamac]

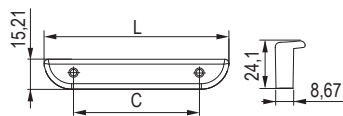

brown matt	black matt	drilling pitch C (mm)	length L (mm)
543767	543766	64	94
543769	543768	224	254

Envel [Zamac]

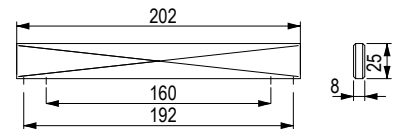

p. 11.33

brushed nickel	black matt	dark brushed gold
482575	482574	482573

Sulky [Zamac]



antique black

202828



antique pewter

202830

Halti [Zamac]

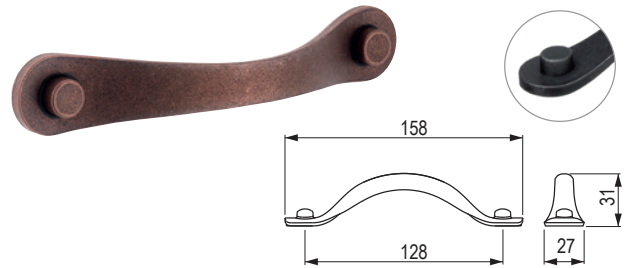

antique black

351829



antique copper

351832

Kentucky [Zamac]

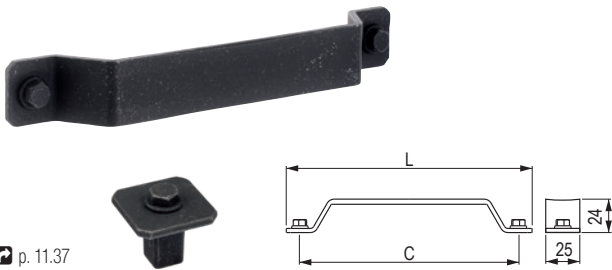

p. 11.37



antique black

202844



antique pewter

202846

drilling pitch
C (mm)

160

length
L (mm)

180

202831

202843

192

212

Andrea [Zn]

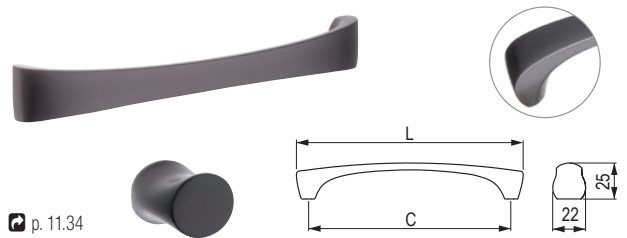

p. 11.34



black nickel
matt

351947

drilling pitch
C (mm)

96

length
L (mm)

110

351948

128

142

351949

160

174

Kink [Zamac]

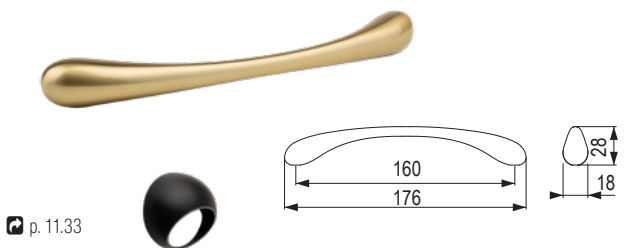

p. 11.33



brushed nickel

482585



dark brushed gold

482584



black matt

482583

Besina [Zamac]

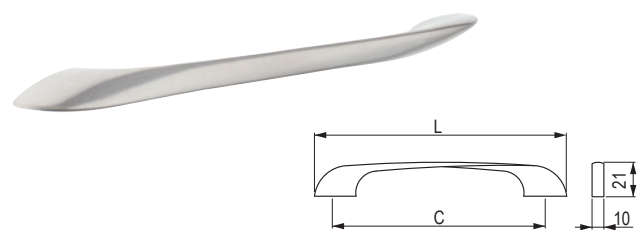

matt nickel

35471

drilling pitch
C (mm)

96

length
L (mm)

121

35481

128

157

35491

160

190

Nomina [Zamac]

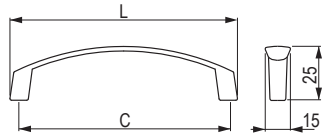

		drilling pitch C (mm)	length L (mm)
matt chrome	matt nickel		
157534	157535	96	108
35232	35231	128	140

Iluna [Zamac]

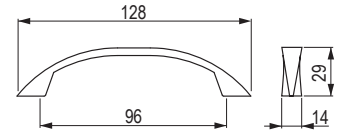

matt chrome	brushed nickel	matt nickel
157527	157528	35301

Ruona [Zamac]

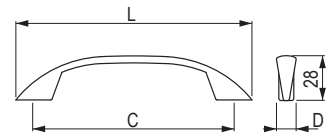

				drilling pitch C (mm)	length L (mm)	width D (mm)
matt nickel	matt chrome	polished chrome	black matt			
35451	35452	35453	35455	96	132	15
35461	35462	35463	×	128	164	16



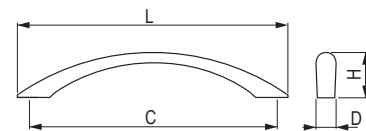



Piombina [Zamac]

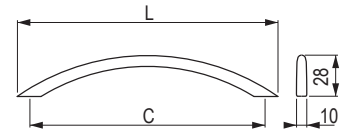

							drilling pitch C (mm)	length L (mm)	width D (mm)	height H (mm)
nickel matt	matt chrome	chrome polished	gold polished	black matt	nickel brushed	antique copper dark				
35251	35252	35253	35254	35255	157520	226980	96	127	12	24
35241	35242	×	×	35245	157521	×	128	164	14	28







Beta [Fe]

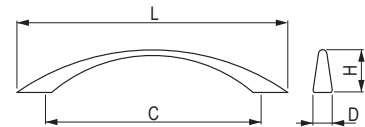

						drilling pitch C (mm)	length L (mm)
35011	35012	35013	35015	35019	35017	96	114
35021	35022	35023	35025	157522	157523	128	146







Anita [Zamac]

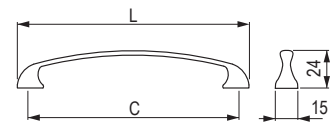

							drilling pitch C (mm)	length L (mm)	width D (mm)	height H (mm)
35071	35072	35073	×	35075		×	64	81	9	23
35081	35082	35083	35084	35085	35089	157525	96	115	10	28
35091	35092	35093	×	35095	×	157526	128	164	11	28

Uroso [Zamac]



						drilling pitch C (mm)	length L (mm)
35631	35632	35633	494594	494593	494604	96	112
35141	35142	×	494603	494602	494605	128	146

Unesa [Zamac]

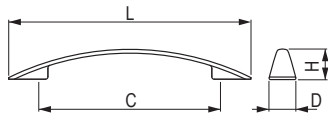

matt chrome



brushed nickel

drilling pitch C (mm)

length L (mm)

width D (mm)

height H (mm)

157529	157530	96	141	16	23
35412	157531	128	186	21	24
157532	157533	160	216	21	24

Vali [Zn]

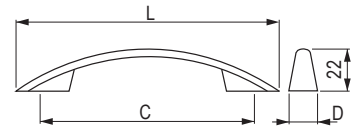

dark antique copper



antique pewter brushed

drilling pitch C (mm)

length L (mm)

width D (mm)

226960	226963	96	140	15
226961	226964	128	174	16
226962	x	160	206	16

Palin [Zamac]

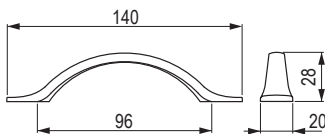

matt nickel

35561

Sema [Alu]

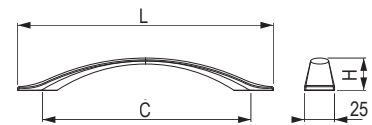

black brushed nickel

drilling pitch C (mm)

length L (mm)

height H (mm)

284053	128	181	27
284054	160	214	27
284055	256	309	29
284056	320	374	29

metal handles and knobs

Kewina [Zamac]

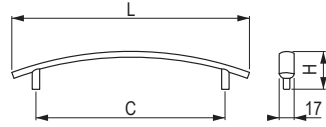

			drilling pitch C (mm)	length L (mm)	height H (mm)
35161	35162	35163	96	124	25
35151	35152	35153	128	156	27

Sakita [Zamac]

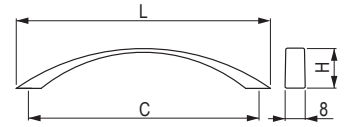

		drilling pitch C (mm)	length L (mm)	height H (mm)
157556	157554	96	116	25
157723	157721	128	150	31

Pelena [Zn]

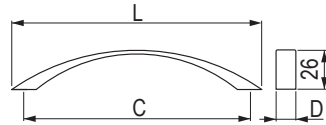

		drilling pitch C (mm)	length L (mm)	width D (mm)
157833	157825	128	140	19
157834	157826	160	174	20
37742	37741	192	228	20
157835	157827	224	257	20

Geneda [Zamac]

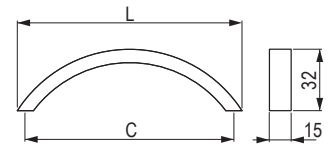

		drilling pitch C (mm)	length L (mm)
35112	157537	96	108
157539	157540	128	140

Malada [Zamac]

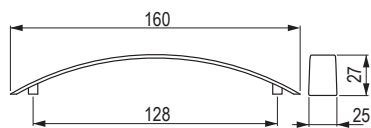

35832	35837

Fiona [Zamac]

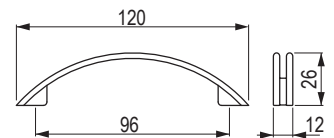

35041	35042	35043

Ruota [Zamac]

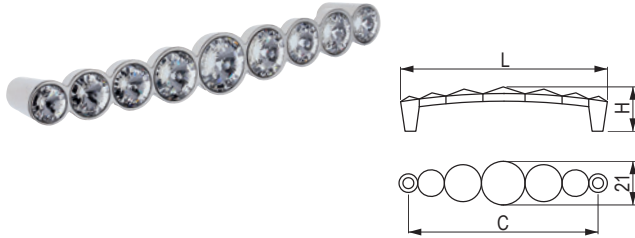

polished chrome	drilling pitch C (mm)	length L (mm)	height H (mm)
US008	32	48	26
US007	96	114	30
US006	128	145	30

Enza [Zamac]

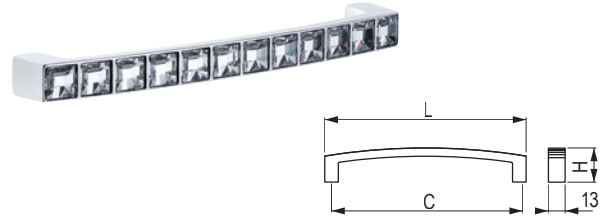

polished chrome	drilling pitch C (mm)	length L (mm)	height H (mm)
US004	96	107	22
US001	128	140	25

Kutta [Zamac]

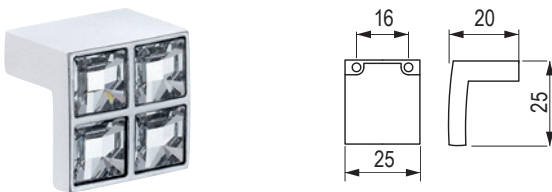

polished chrome
US005

Kutta [Zamac]

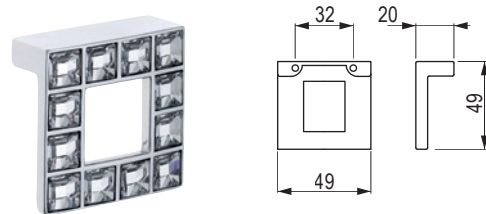

polished chrome
US002

Ruota [Zamac]

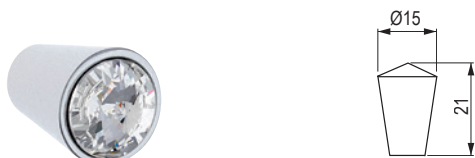

polished chrome
US011

Enza [Zamac]



polished chrome
US003

Blink [Zamac]

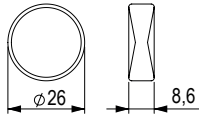

brushed nickel

482578



dark brushed gold

482577



black matt

482576

Envel [Zamac]

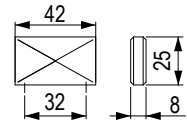

brushed nickel

482572



dark brushed gold

482570



black matt

482567

Tonk [Zn]

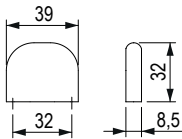

brushed nickel

489334



brushed gold

489335



black matt

489333

Kink [Zamac]

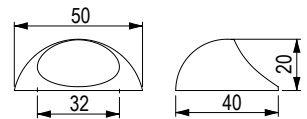

brushed nickel

482582



dark brushed gold

482581



black matt

482579

Mesa [Zamac]

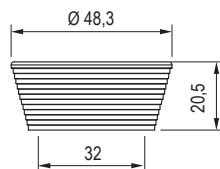

brushed gold

543764



brown matt

543765



black matt

543763

Bella [Zamac]

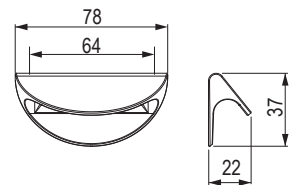

matt gold

396163



black matt

543785

Conic [Alu]

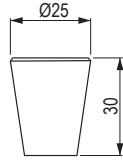

anodised aluminium

401557



matt gold

401558



brown matt

401556



black matt

401555

Iroko [Zn]

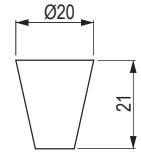

matt chrome

37251



brushed nickel

37252

Mella [Alu]

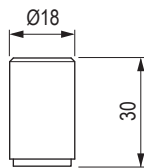

matt gold

396167



black matt

396166

Ota [Fe]

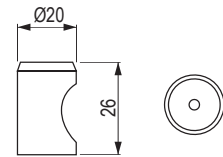

brushed stainless steel

202884

Andrea [Zamac]

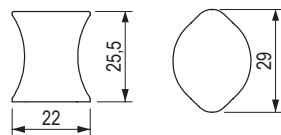

black matt nickel

351946

Ruza [Zn]

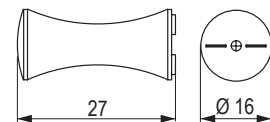

matt chrome

157290



polished chrome

157292



brushed nickel

157291



black matt

157293

metal handles and knobs

Jota [Zamac]

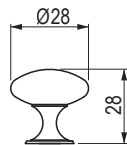

brushed nickel	white polished	matt nickel	matt chrome	polished chrome	polished gold	matt gold	black matt
35007	401575	35001	35002	35003	35004	494606	35005

Evan [Zamac]

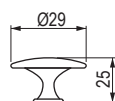

matt nickel	matt chrome	polished chrome	black polished	black matt
401571	401572	401573	401574	401570

Marusa [Zamac]

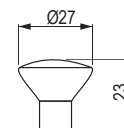

matt nickel	matt chrome	polished chrome
35171	35172	35173

Koby [Alu]

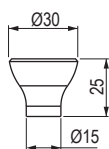
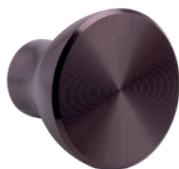

anodised aluminium	brown matt	black matt
401561	401560	401559

Galka [Zamac]

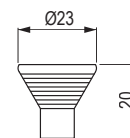

polished chrome	matt chrome
289671	289672

Tomic [Zamac]

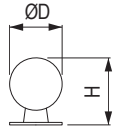

				width D (mm)	height H (mm)
35261	35262	35263	×	18	23
35271	35272	35273	35274	25	32

Boise O [Zamac]

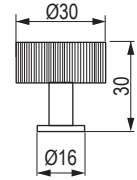

dark brushed gold

544828



black matt

544827

Boise T [Zamac]

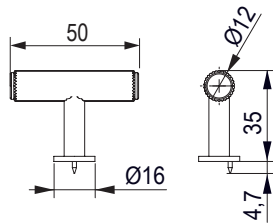

dark brushed gold

544830



black matt

544829

Joliet [zamac/alu]

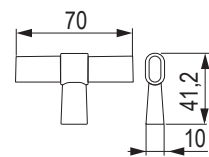
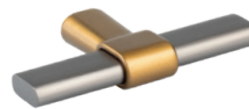

champagne bronze

547173



steel grey / black matt

547175



champagne bronze / steel grey

547174

Peblo [PWC]

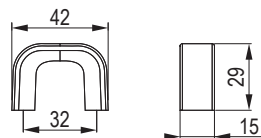

earth

543772



concrete

543771

Recife II [Zamac]

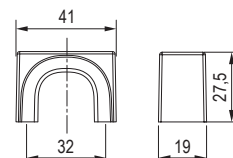

brushed nickel

543776



brown matt

543777



black matt

543775

metal handles and knobs

Hrazda [Fe/Alu]

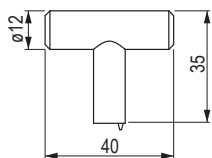

matt nickel

402377



matt chrome

402378



polished chrome

402379



brushed nickel

402380



anodised aluminium

402381

Peca [Zn]

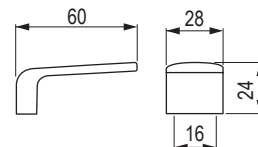

polished chrome / stainless steel imitation

246019



polished chrome / white matt

246011

Tinto [Zamac]

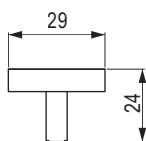

matt chrome

36313



polished chrome

36314

Prisma [Alu]

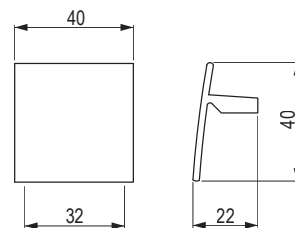

matt chrome

42016



stainless steel imitation

42017

Kentucky [Zamac]

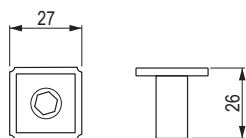

antique black

351834



antique pewter

351836

Frame [Zamac]

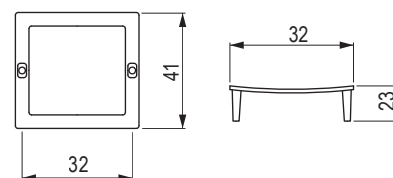

stainless steel imitation

42096



black matt

396168

Menfi [Zamac]

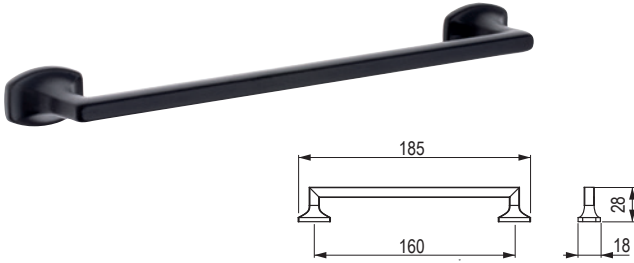

black matt
400314

Menfi [Zamac]

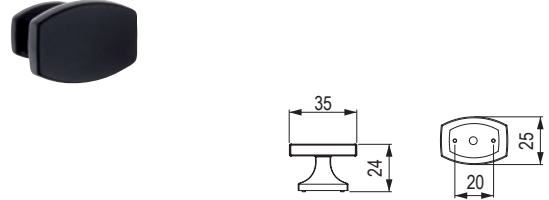

black matt
400316

Tomo [Zn]

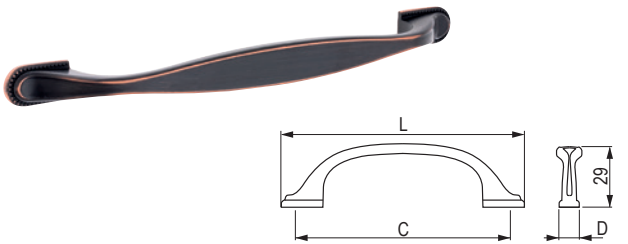

antique pewter brushed	antique copper dark	drilling pitch C (mm)	length L (mm)	width D (mm)
226919	226920	96	132	14
226921	226922	160	204	16

Tomo [Zn]

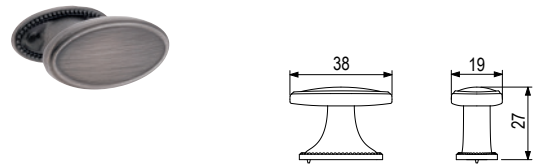

antique pewter brushed
226917

antique copper dark
226918

Victoria [Zamac]

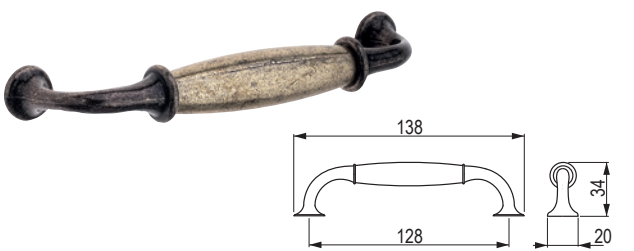

antique black
42103

antique bronze
157685

Victoria [Zamac]



antique black
42104

antique bronze
157684

Turia [Zn]

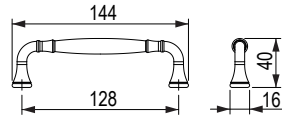

brushed nickel

494695



antique gold

494710



black matt

494709

Turia [Zn]

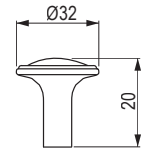

matt nickel

157300



matt chrome

157301



brushed nickel

157302



polished chrome

157303



antique gold

157304



black matt

494679

Rustik [Zamac]

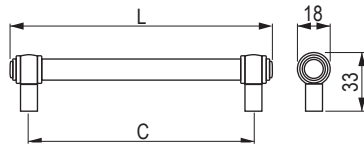

antique gold

296149



antique pewter
brushed

296156

drilling pitch
C (mm)

128

length
L (mm)

149

296150

296157

160

181

296154

296161

320

341

Rustik [Zamac]

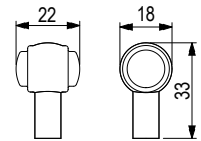

antique gold

296164



antique pewter
brushed

296165

Country [Zamac]

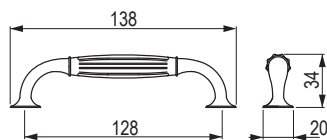

antique gold /
beige porcelain

157681



antique bronze /
beige porcelain

42100

Country [Zamac]

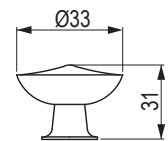
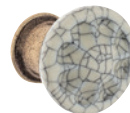

antique bronze /
beige porcelain

42102



antique gold /
beige porcelain

157679

Gipa [Zamac]

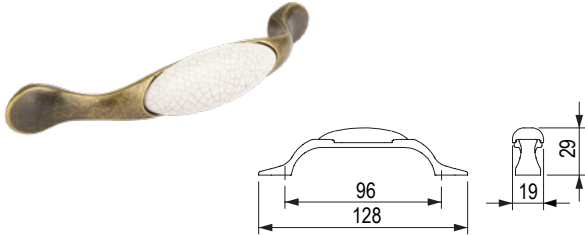

antique gold / white porcelain

309009



antique gold / cracked porcelain

309010

Gipa [Zamac]

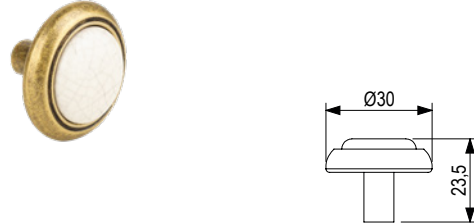

antique gold / white porcelain

309013



antique gold / cracked porcelain

309012

Sara [Zamac]

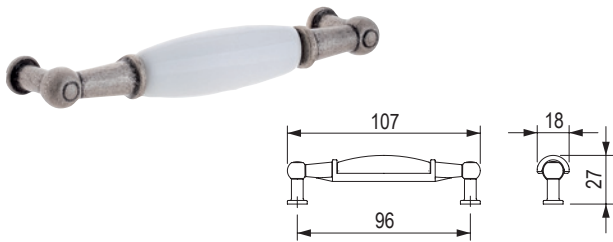

antique pewter / white porcelain

288823



antique gold / white porcelain

309006

Sara [Zamac]



antique pewter / white porcelain

288820



antique gold / beige porcelain

288821

Margarita [Zamac]



antique pewter / porcelain / motif

288805



antique gold / porcelain / motif

288808



antique pewter / white porcelain

288806



antique gold / beige porcelain

288807



brown / porcelain / motif

288809

drilling pitch C (mm)

96

length L (mm)

127

width D (mm)

25

288800

288803

288801

288802

288804

128

159

26

Margarita [Zamac]

antique pewter / porcelain / motif	antique pewter / white porcelain	antique pewter / white porcelain	antique gold / beige porcelain	brown/porcelain/motif	
288810	288813	288811	288812	288814	

Vintage [Zamac]

antique gold / porcelain/motif	
360611	

Vintage [Zamac]

antique gold / porcelain/motif	
360609	

Serena [Zamac]

antique gold	drilling pitch C (mm)
157283	128
	length L (mm)
	147

Serena [Zamac]

antique gold	
157285	

Corsica [Zamac]

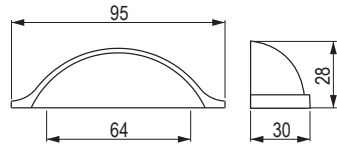

antique black

202869

Loka [Zamac]

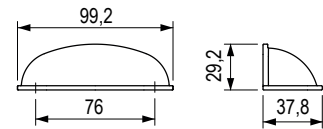

brushed nickel

409056



matt gold

494174



black matt

494175

Cona [Zamac]

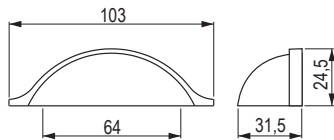

antique gold

285004

Bold [Zamac]

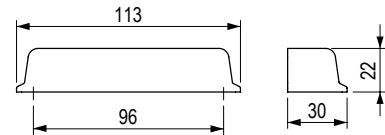

brushed nickel

494195



black matt

494194

recessed handles and profiles

Panel F [Zamac]

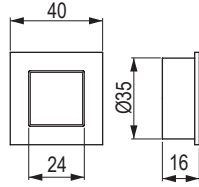

brushed nickel

401584

Ring F [Zamac]

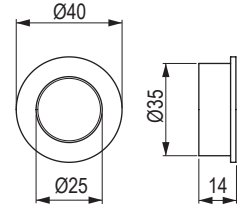

brushed nickel

401588

Kaniva [Zamac]

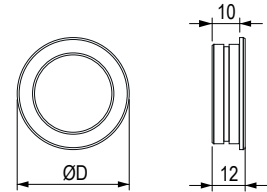

matt nickel

35531

x



matt chrome

35532

35542



polished chrome

35533

x



black matt

482746

482745

length
D (mm)

40

50

recess dimensions
(milling) (mm)

35 × 35 × 10

42 × 42 × 10

Dunk [Zamac]

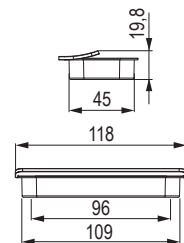

brushed gold

543761



brown matt

543762



black matt

543760

recess dimensions
(milling) (mm)

109 × 45 × 13,5

recessed handles and profiles

Avoca [Zn]

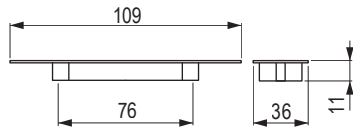

Model is designed primarily for sliding doors.

		recess dimensions (milling) (mm)
matt chrome	matt nickel	
37771	37773	

Anetta [Alu]

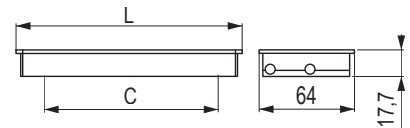

	drilling pitch C (mm)	length L (mm)	recess dimensions (milling) (mm)
37870	96	120	114 × 57,5 × 14,5
37871	128	150	144 × 57,5 × 14,5

Shellby [Zamac]

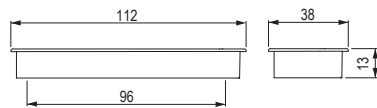

			recess (milling) (mm)
brushed nickel	antique bronze	black matt	
398092	398094	398095	

Nave [Alu]



		drilling pitch C (mm)	length L (mm)	recess dimensions (milling) (mm)
225013	225017	96	106	101 × 36 × 11
225014	225018	160	170	166 × 36 × 11

Misura [Zamac]

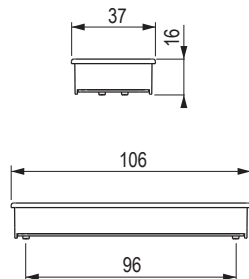

	recess (milling) (mm)
dark gold	
506047	

Carpi [Zamac]

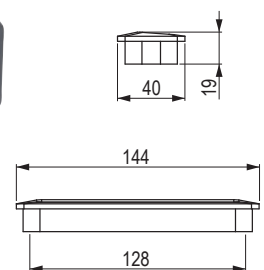

		recess (milling) dimensions) (mm)
anthracite	matt nickel	
400311	400312	

recessed handles and profiles

Gliss [Zamac]

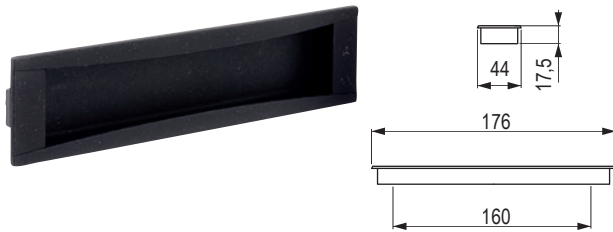

Model is designed primarily for sliding doors.

		recess dimensions (milling) (mm)
antique black	antique pewter	
351940	351941	172 × 39 × 14

Madrid [Zamac]

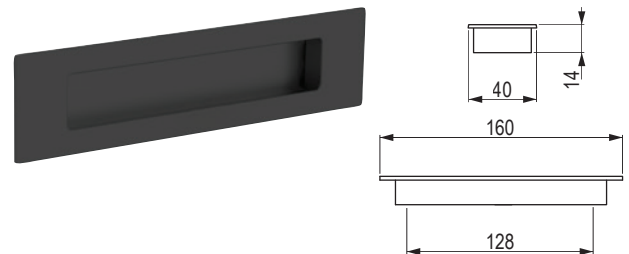

Model is designed primarily for sliding doors.

		recess dimensions (milling) (mm)
silver	black matt	
36334	482586	142,6 × 30 × 12

Rulida [Alu]

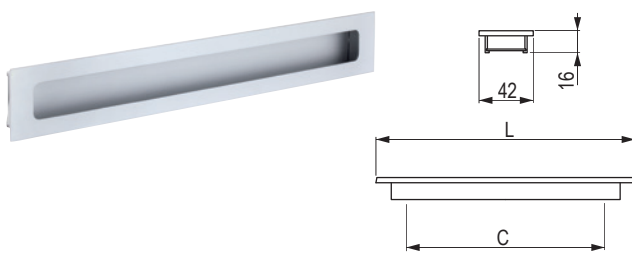

	drilling pitch C (mm)	length L (mm)	recess dimensions (milling) (mm)
anodised aluminium			
37006	128	145	136 × 33 × 14
37007	256	278	267 × 33 × 14

Orinoco [Zn]

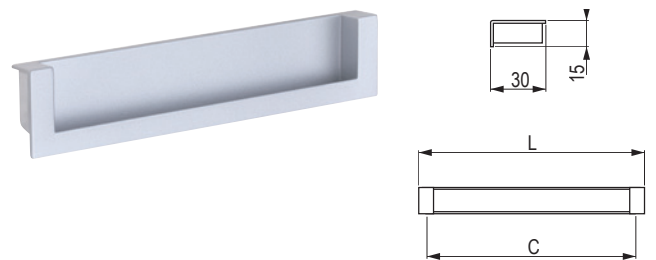

	drilling pitch C (mm)	length L (mm)	recess dimensions (milling) (mm)
silver			
157785	96	106	102 × 27 × 11
37201	128	138	134 × 27 × 11

Rapid [Zamac]

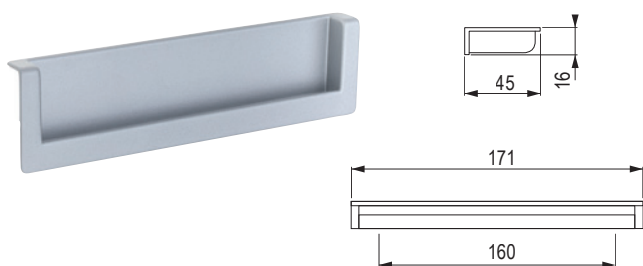



	recess dimensions (milling) (mm)
silver	
215529	167 × 40 × 12,5

recessed handles and profiles

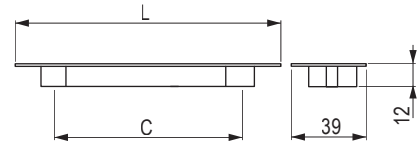
Pesara [Zn]



		drilling pitch C (mm)	length L (mm)	recess dimensions (milling) (mm)
157782	157783	96	107	102 × 28 × 10
157781	37781	128	139	135 × 28 × 10

Malena [Alu]

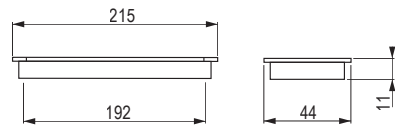
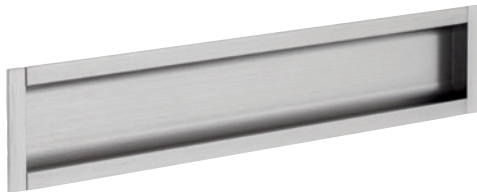

❗ Model is designed primarily for sliding doors.





Malena handle can be used for sliding 18 mm doors due to the small thickness.

	recess dimensions (milling) (mm)
226998	209 × 38 × 9

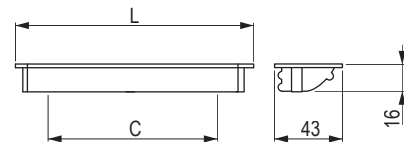
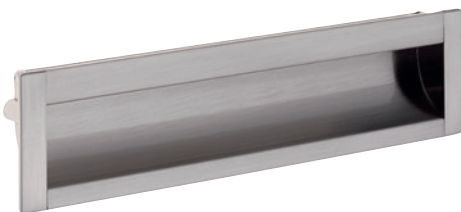

Concava [Zamac]



		drilling pitch C (mm)	length L (mm)	recess dimensions (milling) (mm)
37332	37333	96	109	103 × 36 × 14
157777	157778	128	140	137 × 36 × 14
37192	37193	160	171	167 × 36 × 14

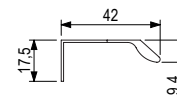
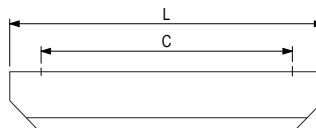



Lori II ^[Alu]

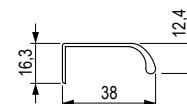

				
stainless steel imitation	dark brushed gold	brushed black	drilling pitch C (mm)	length L (mm)
544802	544797	544807	64	80
544803	544798	544808	160	200
544804	544799	544809	256	350
544805	544800	544810	480	500
544806	544801	544811	1056	1200

Nary ^[Alu]





					
coffee matt	stainless steel imitation	black matt	anthracite	drilling pitch C (mm)	length L (mm)
544784	456882	456876	460523	32	50
x	456883	456877	460524	64	100
544785	456884	456878	460525	160	200
x	456885	456879	460526	256	300
544786	456886	456880	460527	352	400
x	456887	456881	460528	480	500
x	544788	544787	x	1056	1200

recessed handles and profiles

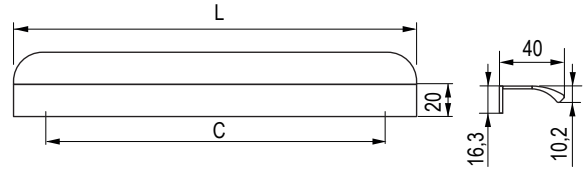





Bowie [Alu]

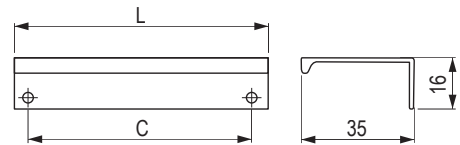

				
brushed coffee	dark brushed gold	brushed black	pitch C (mm)	length L (mm)
544766	544772	544778	32	50
544767	544773	544779	64	100
544768	544774	544780	160	200
544769	544775	544781	256	350
544770	544776	544782	480	500
544771	544777	544783	1056	1200

Lucata [Alu]





							
white matt	polished chrome	stainless steel imitation	anodised aluminium	brushed gold	black matt	drilling pitch C (mm)	length L (mm)
360347	227265	227271	227276	474383	360352	32	52
360348	227266	227272	227277	474384	360353	64	84
360349	227267	227273	227278	474385	360354	96	116
360350	227269	227274	227279	474386	360355	160	180
360351	227270	227275	227280	474387	360356	320	340
354155	354158	354153	354152	474388	354154	480	500
x	x	494663	284334	x	494662	x	3000

recessed handles and profiles

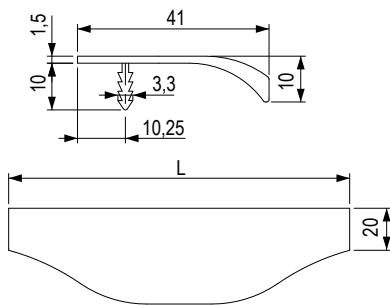

Sophia [Alu]

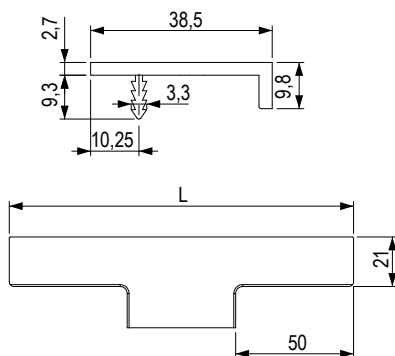

 stainless steel imitation	 black matt	length L (mm)
494256	494266	146
494248	494261	196
494674	494673	246
494246	494263	296
494247	494264	346
494253	494265	396
494250	494262	446
494249	494267	496
368532	494666	546
494252	494268	596
494254	494269	696
494255	494270	796
494251	494271	896
494257	494272	996
494258	494273	1196

Ramara [Alu]





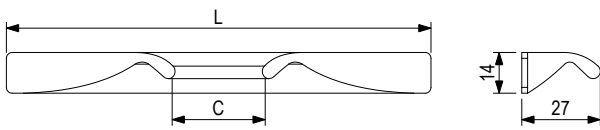

 stainless steel imitation	 anodised aluminium	 brushed black	length L (mm)
244831	244834	366458	146
244832	244835	366459	196
487951	487953	487954	246
202816	244836	366460	296
202817	244837	366461	346
244833	244838	366462	396
202818	244839	366463	446
202819	244840	366464	496
494678	494677	494676	546
202820	244841	366465	596
487955	487956	487957	696
202821	244842	366466	796
202822	244843	366467	896
202823	244844	366468	996
202824	244845	366469	1196

recessed handles and profiles





Tende [Alu]

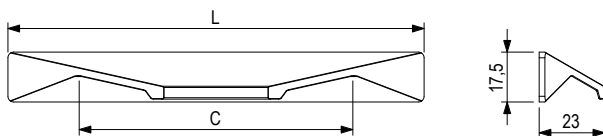

 stainless steel imitation	 black matt	 anthracite	 anodised aluminium	drilling pitch C (mm)	length L (mm)
456845	456858	456819	456832	16/32	146
456846	456859	456820	456833	32/64	196
456847	456860	456821	456834	128/160	296
456848	456861	456822	456835	160/224	346
456849	456863	456823	456836	192/256	396
456850	456866	456824	456837	224/288	446
456851	456867	456825	456838	288/352	496
456852	456869	456826	456839	384/448	596
456853	456870	456827	456840	480/544	696
456854	456871	456828	456841	576/640	796
456855	456872	456829	456842	672/736	896
456856	456873	456830	456843	768/832	996
456857	456874	456831	456844	960/1024	1196

Zoid [Alu]



 white matt	 stainless steel imitation	 anodised aluminium	 black matt	drilling pitch C (mm)	length L (mm)
456762	456784	456799	456748	64/96	146
456770	456785	456800	456749	64/96	196
456771	456786	456801	456750	128/160	296
456772	456787	456802	456751	160/224	346
456775	456788	456803	456752	192/256	396
456776	456789	456804	456753	224 /288	446
456777	456791	456805	456754	288 /352	496
456778	456792	456806	456755	384 /448	596
456779	456793	456807	456756	480 /544	696
456780	456794	456808	456758	576 /640	796
456781	456795	456809	456759	672/736	896
456782	456796	456810	456760	768 /832	996
456783	456797	456811	456761	960 /1024	1196

Juvio [Alu]

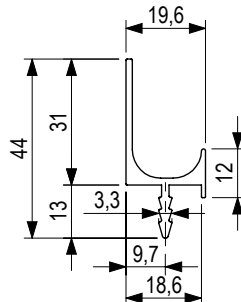
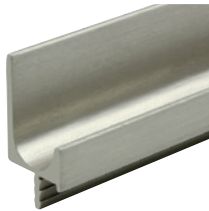

				length L (mm)	laminate thickness (mm)
506395	506406	x	x	297	18
506396	506407	x	x	347	18
506397	506408	x	x	397	18
506398	506409	x	x	447	18
506399	506410	x	x	497	18
506400	506411	x	x	597	18
506401	506412	x	x	697	18
506402	506413	x	x	797	18
506403	506414	x	x	897	18
506404	506415	x	x	997	18
506405	506416	x	x	1197	18
276815	276814	466366	466365	2900	18

Paolo [Alu]

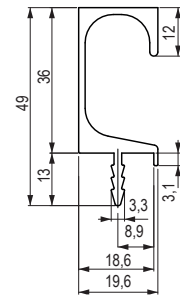
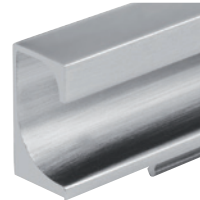

				length L (mm)	laminate thickness (mm)
506366	506384	x	x	297	18
506367	506385	x	x	347	18
506368	506386	x	x	397	18
506369	506387	x	x	447	18
506370	506388	x	x	497	18
506371	506389	x	x	597	18
506374	506390	x	x	697	18
506376	506391	x	x	797	18
506377	506392	x	x	897	18
506378	506393	x	x	997	18
506379	506394	x	x	1197	18
276820	276821	466371	466368	2900	18

Juvio L [Alu]

- Profile for door thickness 19–20 mm.

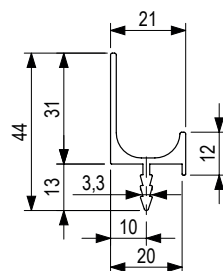

		length L (mm)	laminate thickness (mm)
494712	494711	2900	20

Paolo L [Alu]

- Profile for door thickness 19–20 mm.

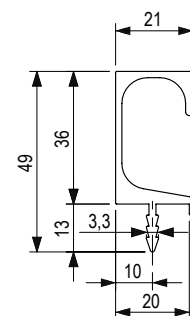

		length L (mm)	laminate thickness (mm)
494714	494713	2900	20

Fano [Alu]

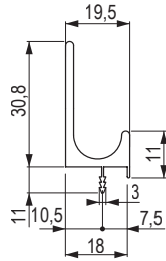

anodised aluminium

UC001



black matt

399431

length
L (mm)

2450

laminate
thickness
(mm)

18

Ria [Alu]

- Profile for the edge of a bevelled front

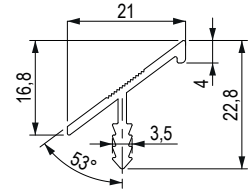

anodised aluminium

491992



black matt

491993



stainless steel
imitation

491994

length
L (mm)

2900

laminate
thickness
(mm)

18

Lungo [Alu]

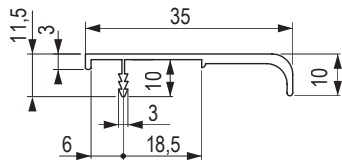

anodised aluminium

UC004

length
L (mm)

2950

laminate
thickness
(mm)

18

Gola system

System for handleless door opening. Includes horizontal and vertical profiles (wardrobes and kitchen assemblies built from the floor to the ceiling).



Horizontal door "J" profile.

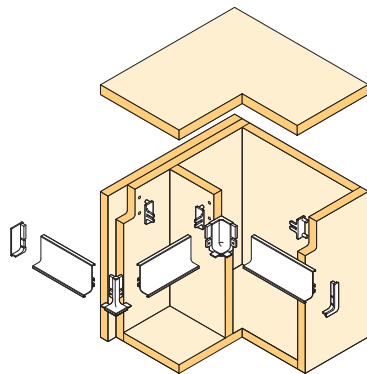

Horizontal drawer "C" profile.

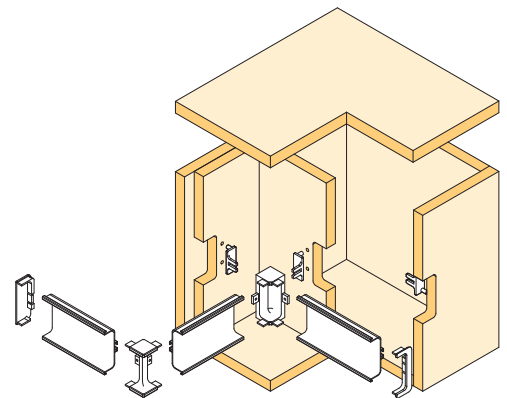

vertical profiles (side and centre)

GOLA horizontal profiles

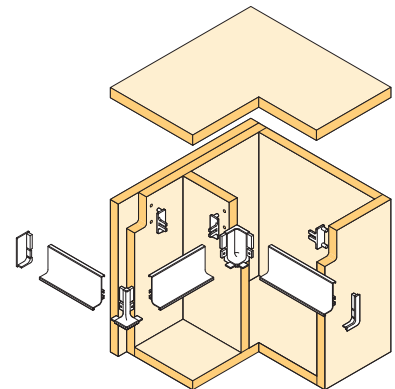
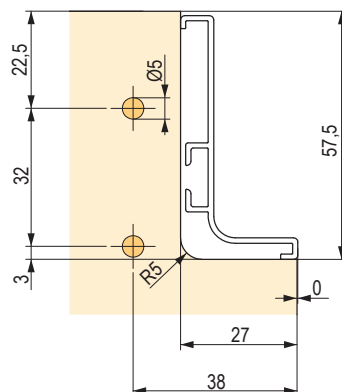
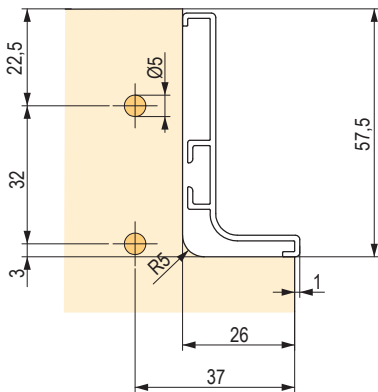

Door J profile 4,100 mm

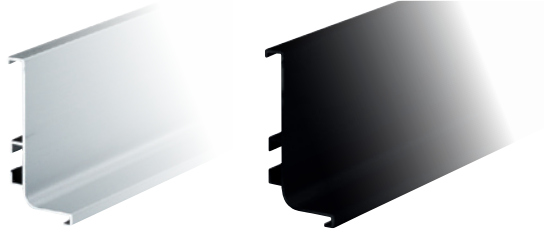

imitation of stainless steel	anodised aluminium	white semi-gloss	black matt	dark brushed gold
228304	151631	284149	404389	502335

- profile under the worktop
- the assembly dimensions apply for profile overlap of 1 mm
- if you wish to have the profile levelled with the surface, increase them by 1 (37⇒38, 26⇒27)

Door J profile end caps

1.

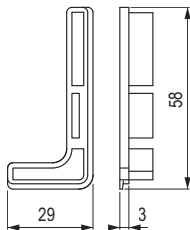

2.

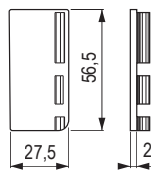

3.

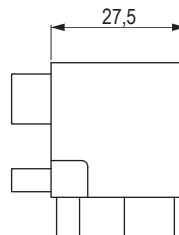

4.

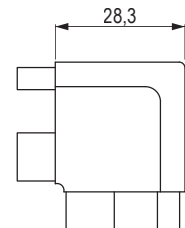

	silver	white	black	imitation of stainless steel	anodised aluminium	black matt	dark brushed gold	white semi-gloss
	PLASTIC			METAL				
1	232861	289124	404394	228305	151632	404397	502337	×
2	284152	289121	404392	284150	284151	404399	502338	×
3	×	×	×	228306	151717	404393	502339	284153
4	×	×	×	228307	151718	404391	502340	284154

- set of R + L end pieces

Drawer C profile 4,100 mm



imitation of stainless steel

228308



anodised aluminium

151732



white semi-gloss

284155



black

404404



dark brushed gold

502336

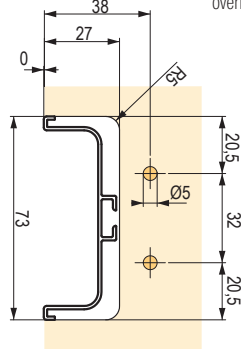
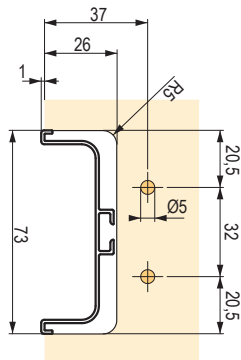

- profile for using between drawers one above the other
- the assembly dimensions apply for profile overlap of 1 mm
- if you wish to have the profile level with the surface, increase them by 1 (37 ⇒ 38, 26 ⇒ 27)

Drawer C profile end cap

1.

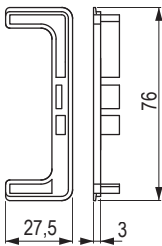

2.

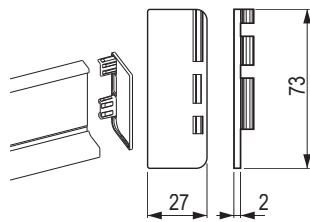

3.

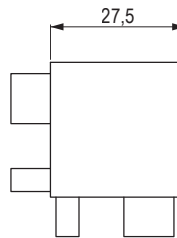

4.

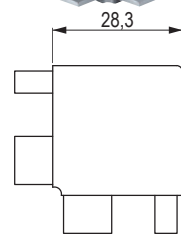

silver	white	black	imitation of stainless steel	anodised aluminium	black matt	dark brushed gold	white semi-gloss

	description	PLASTIC			METAL				
1	open end cap	232862	289123	404414	228309	151785	404415	502341	×
2	closed end cap	284158	289122	404406	284156	284157	404417	502342	×
3	outer corner	×	×	×	228310	151786	404413	502343	284159
4	inner corner	×	×	×	228311	151821	404405	502344	284160

- set of R + L end pieces
- do not use if the profile is between the cabinet sides

Drawer and door profile clips

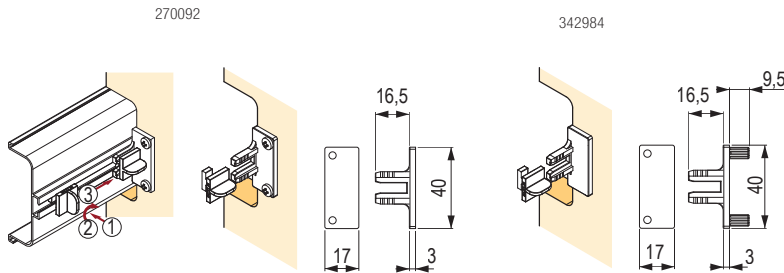

plastic	plastic, clip with pins
270092	342984

- set of 2 clips for fixing the profile to the sides of the cabinet
- a sophisticated solution for mounting the profile into an assembled cabinet

Door J profile 4,100 mm with LED

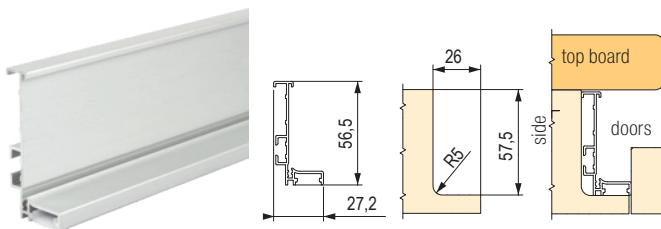

imitation of stainless steel	anodised aluminium	white semi-gloss	black matt	dark gold brushed
504523	504524	504525	504526	504527

- ❗ The LED strip is not included and must be ordered separately.
- ❗ Diffuser 504528 must be purchased additionally

- profile under the worktop
- the assembly dimensions apply for profile overlap of 1 mm
- if you wish to have the profile levelled with the surface, increase them by 1 mm (37⇒38, 26⇒27)

Drawer C profile 4,100 mm with LED

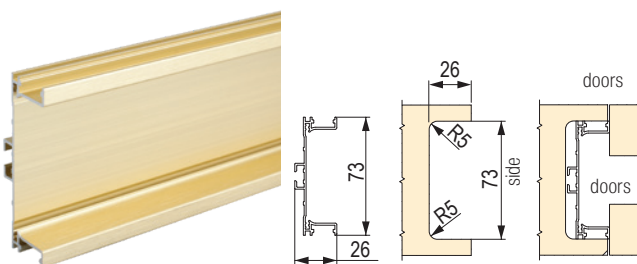

imitation of stainless steel	anodised aluminium	white semi-gloss	black matt	dark brushed gold
505493	505494	505495	505496	505485

- ❗ The LED strip is not included and must be ordered separately.
- ❗ Diffuser 504528 must be purchased additionally

- profile for using between drawers one above the other
- the assembly dimensions apply for profile overlap of 1 mm
- if you wish to have the profile level with the surface, increase them by 1 (37 ⇒ 38, 26 ⇒ 27)

Gola cover (diffuser) for door J and C profile with LED 4.1 m

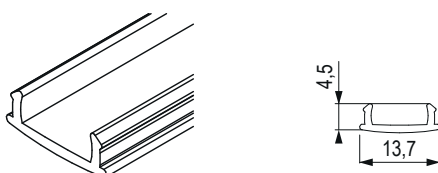

transparent plastic

504528

Gola vertical profiles for handleless opening of cabinet doors

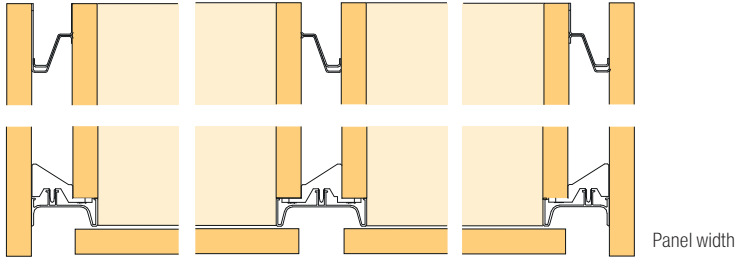

Edge profile Snap on 2,700 mm

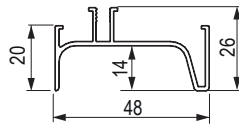
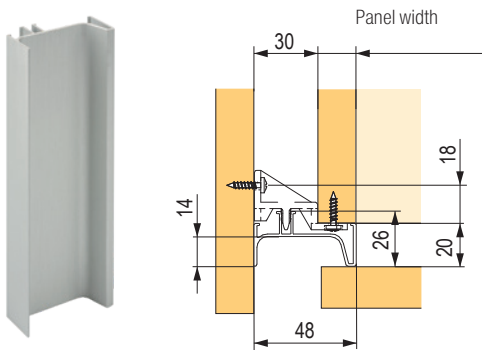

stainless steel imitation	anodised aluminium	white semi-gloss	black matt	dark brushed gold
502345	502346	502348	502349	502350

Centre profile Snap on 2,700 mm

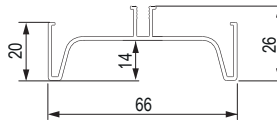
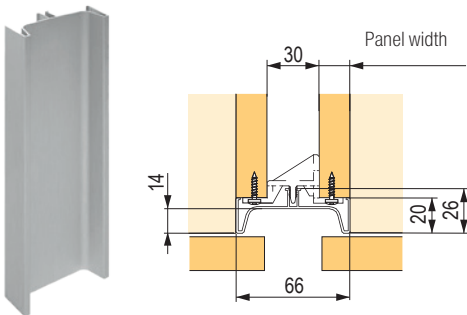

stainless steel imitation	anodised aluminium	white semi-gloss	black matt	dark brushed gold
502351	502352	502353	502354	502355

Accessories for Snap on vertical profiles

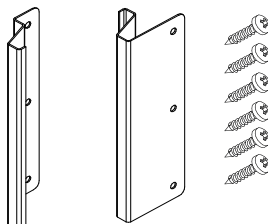

code	description
504520	metal distance piece for edge and centre profile

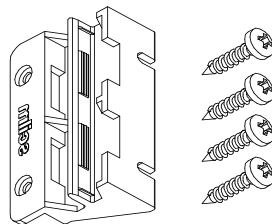

code	description
504521	plastic snap on front panel for edge profile

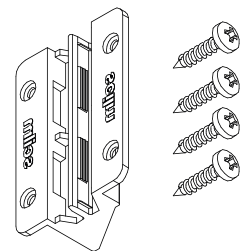

code	description
504522	plastic snap on front panel for centre profile

• material: plastic

Accessories for Snap on vertical profiles

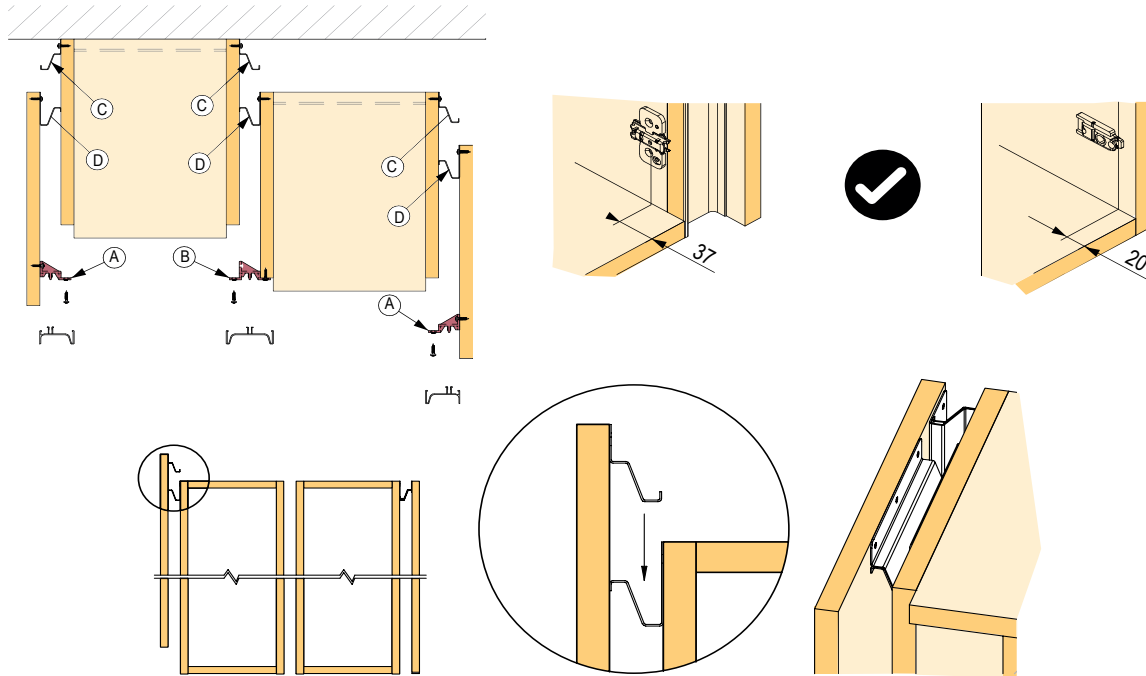

Gola Profile 1275 for built-in oven

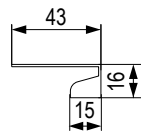

stainless steel imitation	anodised aluminium	white semi-gloss	black matt	length (mm)
547280	529673	529674	529673	580

- heat protection
- the profile is used in combination with Snap on vertical profiles

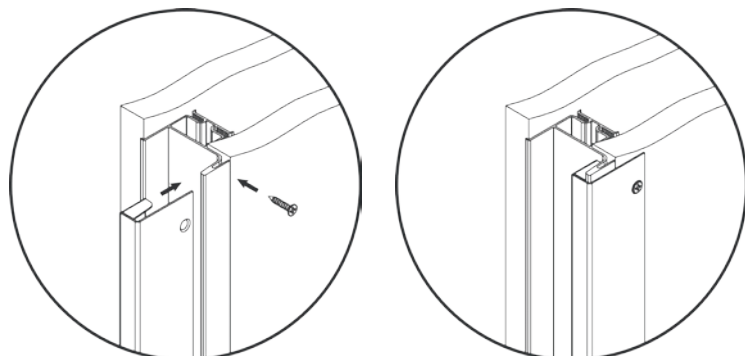

recessed handles and profiles

Door profile 3,900 mm for top cabinets

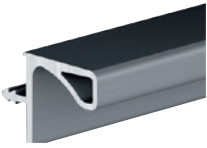
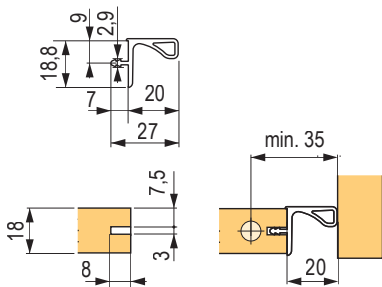
stainless steel imitation	anodised aluminium	white polished	black matt	dark brushed gold
228312	156848	360875	502356	502364

Door profile 3900 mm for top cabinets with seal

	thickness (mm)
366368	18
302379	16

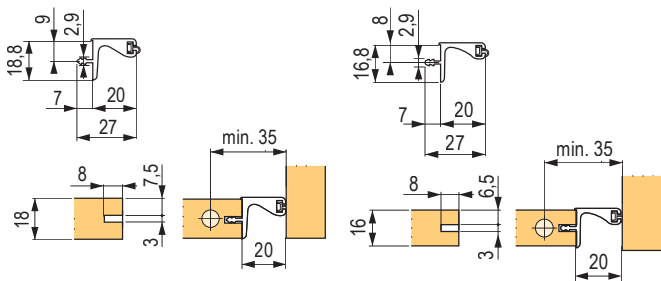
Knock-in profiles for material thickness 18 mm

CD0051



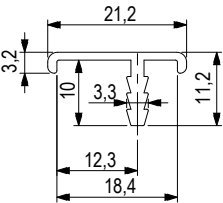

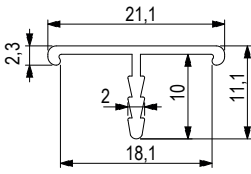
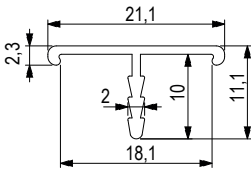
313756

	length L (mm)
313756	2 900

Door J profile 2900 mm (profile under the worktop)

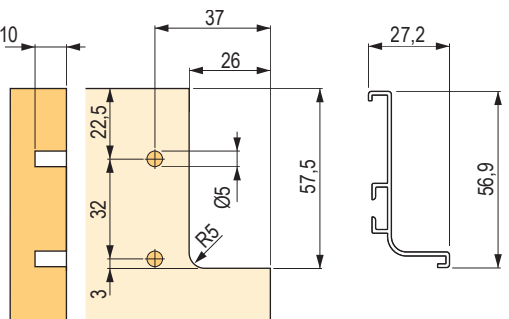
stainless steel imitation	anodised aluminium
313754	313753

Drawer C profile II 2,900 mm

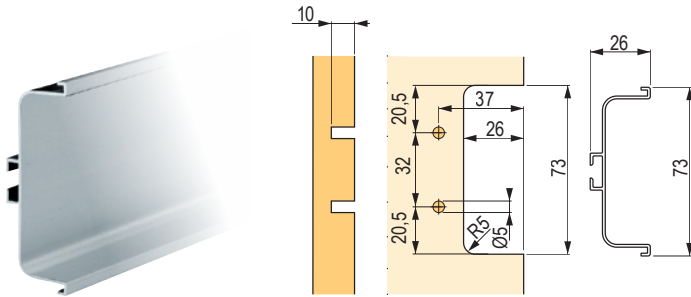

	
stainless steel imitation	anodised aluminium
313752	313751

Clip for drawer and door J and C profile

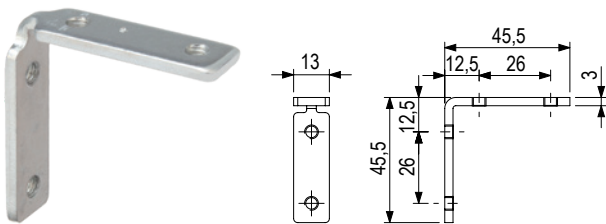

metal
313762

- set of R + L end pieces
- do not use if the profile is between the cabinet sides

Drawer profile end cap

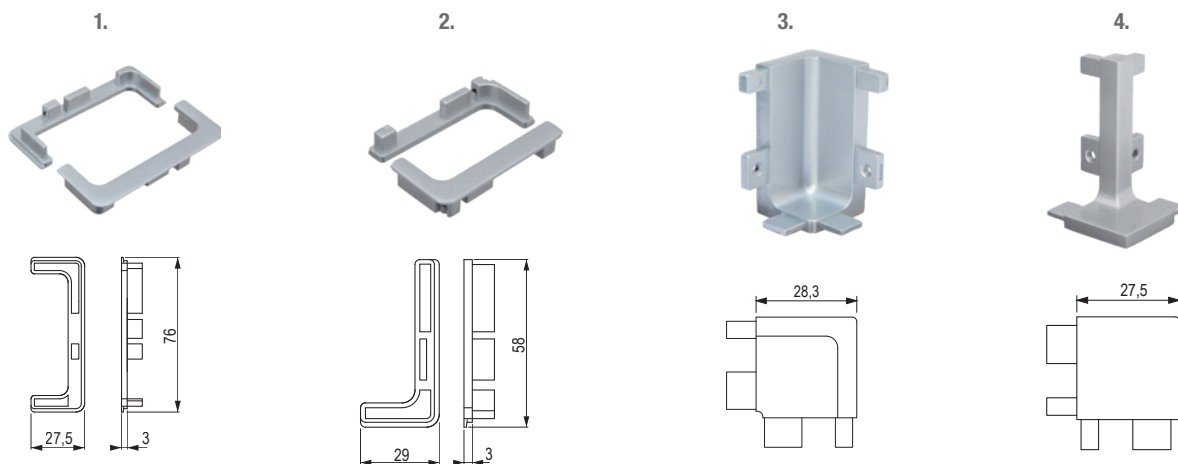



		description
1	313758	open end cap
2	313757	open end cap
3	313759	outer corner
4	313760	inner corner

- set of R + L end pieces
- do not use if the profile is between the cabinet sides

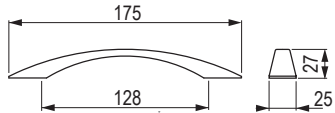
Berga

	
lacquered oak	lacquered beech
09459	09461

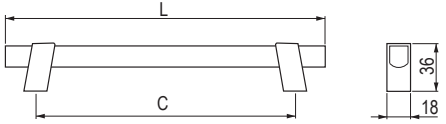

Beam

		
lacquered oak	drilling pitch C (mm)	length L (mm)
402330	192	242
502357	320	370



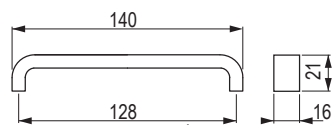

Metra

	
lacquered oak	lacquered beech
351899	351900

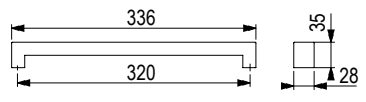
Rail

			
raw oak	lacquered oak	raw ash	lacquered ash
500446	500447	500448	500449

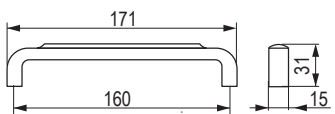

Lynn

		
lacquered walnut	drilling pitch C (mm)	length L (mm)
543785	160	171

Boise

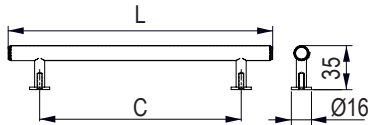
			
lacquered oak / dark brushed gold	lacquered oak / black matt	drilling pitch C (mm)	length L (mm)
549438	549437	160	210
549440	549439	320	370

Mewo

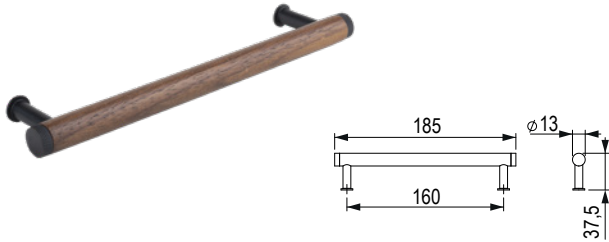

walnut / black matt

497966



walnut / matt gold

497967

Mewo



walnut / black matt

497964



walnut / matt gold

497965

Xin



raw oak

500434



lacquered oak

500435



lacquered walnut

500436



lacquered oak / black

x



lacquered oak / white

x



lacquered oak / grey

x

drilling pitch C (mm)

32

length L (mm)

60,5

500422

500423

500424

500425

500426

500427

192

225

500428

500429

500430

500431

500432

500433

996

1031

Lines

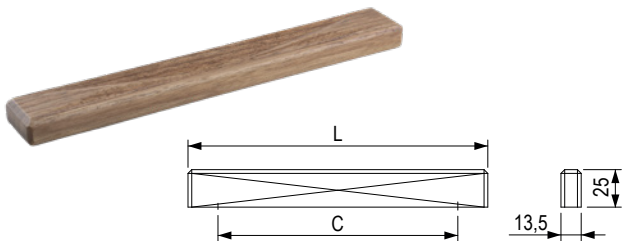

raw oak

500440



lacquered oak

500441



lacquered walnut

500442

drilling pitch C (mm)

160

length L (mm)

200

500443

500444

500445

480

520

Vasca

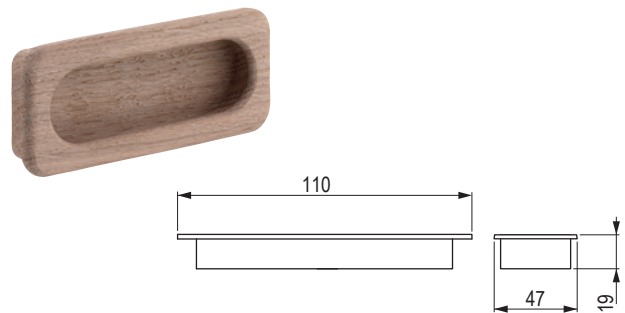

raw oak

351888



raw beech

351889

recess dimensions (milling) (mm)

100 x 40 x 13,5

depth (mm)

13,5

Tine

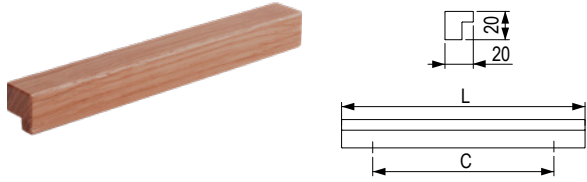

lacquered oak	raw oak	drilling pitch C (mm)	length L (mm)
497682	497685	128	172
497683	497686	320	365
497684	497687	960	1000

Chico

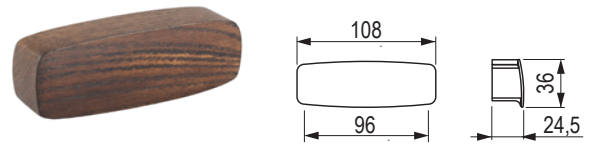

lacquered walnut
543770

Wave

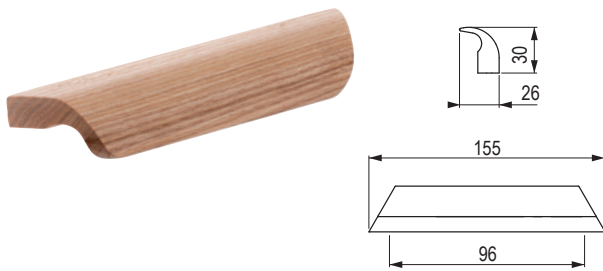

raw oak	lacquered oak
404347	404348

Moku

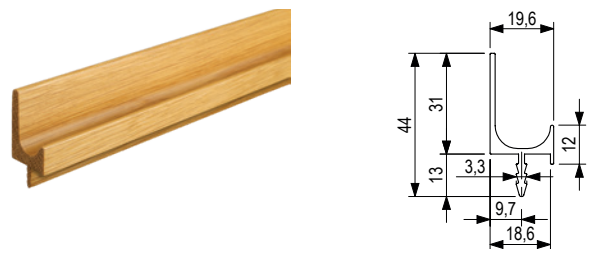

raw oak	lacquered oak	length L (mm)
547185	547184	2400

Ames

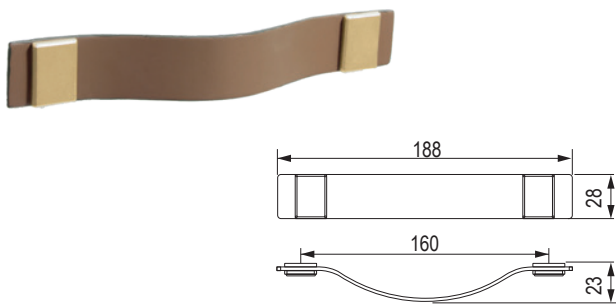

brown
547156

Ames

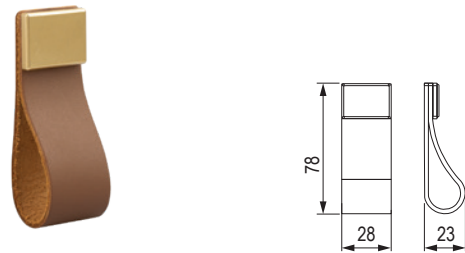

brown
547157

wooden and leather handles and knobs

Square

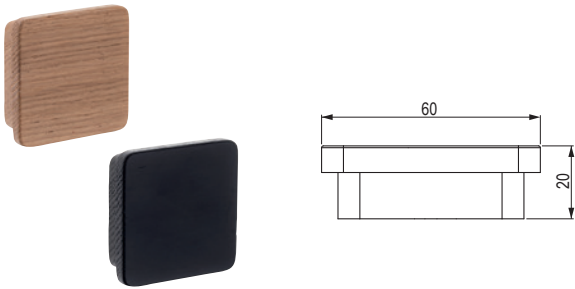

raw oak	lacquered oak	black beech
404337	404338	404341

Hole

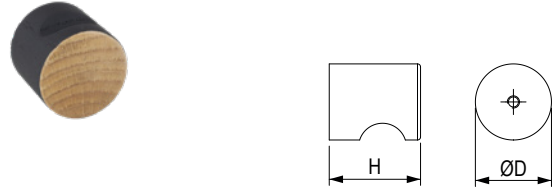

lacquered oak / black	diameter D (mm)	height H (mm)
497674	25	30
497675	40	35

Taper



raw oak	lacquered oak	black	raw beech	lacquered beech	white
404331	404332	404335	404333	404334	404336

Jura



lacquered oak	lacquered pine	lacquered beech
09413	09414	09415







Jacek



lacquered oak	lacquered pine	lacquered beech	raw beech	raw pine
09401	09402	09403	158699	158698

Adam



					
lacquered oak	lacquered pine	lacquered beech	raw beech	lacquered alder	raw pine
09409	09410	09411	158704	09412	158703

Bala

Coloured wood



		
dark blue	violet	olive
212674	09491	09493

Sola

Coloured wood



	
light blue	yellow
158717	158723

Cute

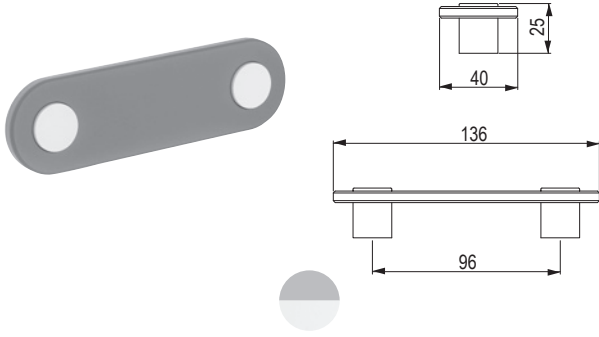

grey/white

405137

Cute



grey/white

405148

P431

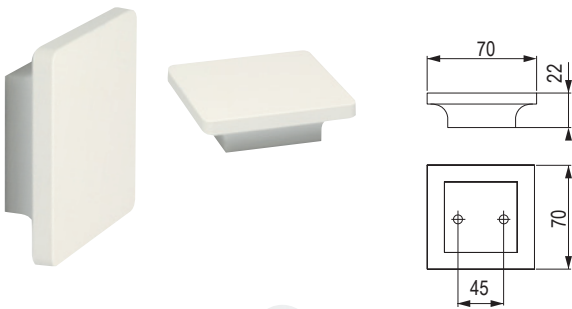

white

265483

P439



white

265486

Spaccata



brown rope

351879

Spaccata

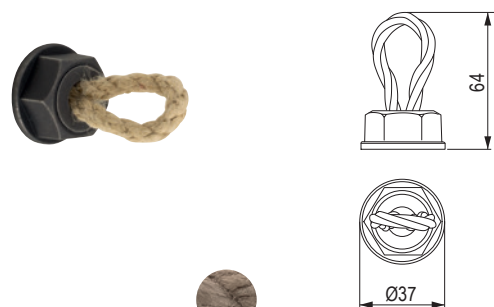

brown rope

382066

Cana

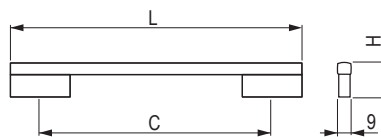

				drilling pitch C (mm)	length L (mm)	height H (mm)
pink 303199	green 303203	white 303211	light blue 303207	128	152	30
303200	303204	303212	303208	160	200	30

Funga

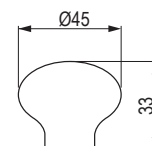

			
pink 303233	green 303234	white 303236	light blue 303235

Palla

Softened plastic

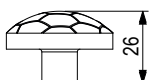
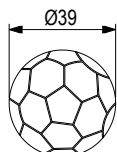

motif
198702

198702

Bottone

Laminated plastic

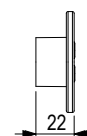
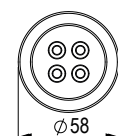

white
351883



blue
351884



pink
351885

351883	351884	351885
---------------	---------------	---------------

children's and plastic handles and knobs

Into

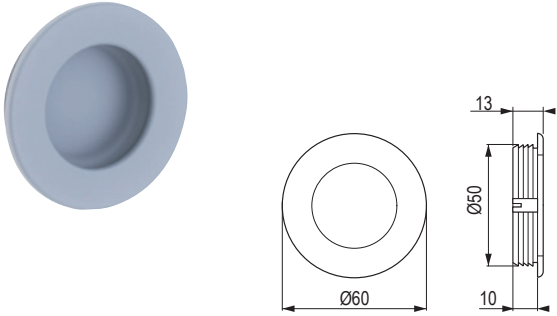

white

405152



black

405154

Large

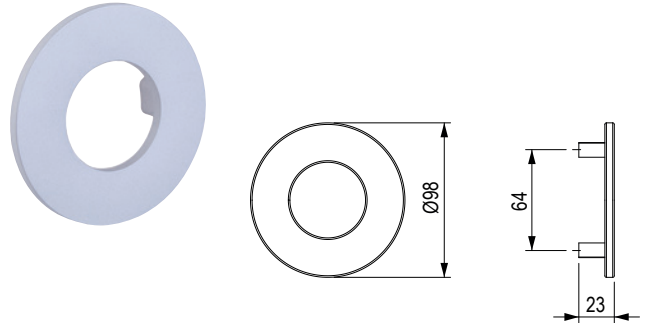

white

405157



grey

405158



pink

405160



hooks

Filip [Stainless steel]

	length L (mm)
372855	52
352456	72

Element [Stainless steel]

brushed stainless steel	polished chrome	brushed gold	brushed black
484696	484697	484700	484698

Balo [Zamac]

black matt
398940

Rudi [Zamac]

brushed nickel	dark brushed gold	black matt
483279	491190	483278

Troy [Zamac]

champagne bronze	steel grey	brushed black
547177	547178	547176

Boise [Zamac]

dark brushed gold	black matt
547181	547180

Doris [Zn]

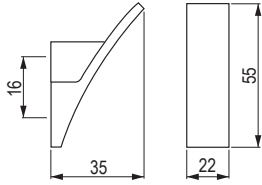

matt chrome

204687



brushed nickel

204688



black matt

544822

Dyan [Zamac]

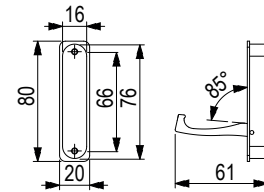

matt nickel

231588



matt chrome

231589

Rini [Zamac]

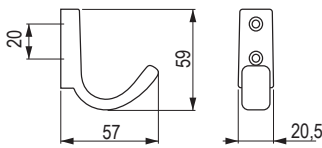

black matt

505995

Rini XL [Zamac]

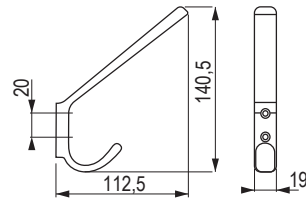

black matt

505996

Peri [Zamac]

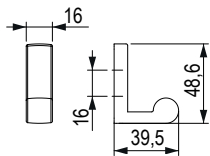

brushed nickel

494191



black matt

494190

Peri XL [Zamac]

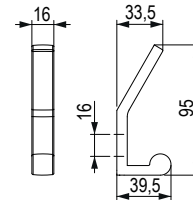

brushed nickel

494193



black matt

494192

Pera [Zamac]

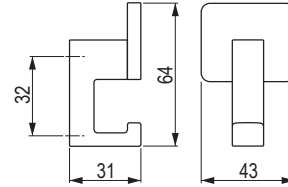

anodised aluminium

77812



brushed nickel

77813



dark matt gold

399803



black matt

356378

Kara S [Zamac]

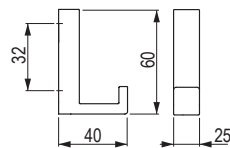

brushed nickel

284988



polished chrome

284991



black matt

355732



white polished

355729

Kara M [Zamac]

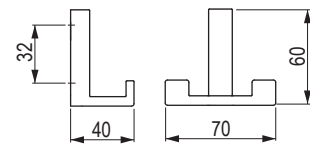

brushed nickel

284989



polished chrome

284992



black matt

355731



white polished

355728

Kara L [Zamac]

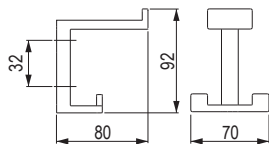

brushed nickel

284990



polished chrome

284993



black matt

355730



white polished

355727

Marell [Zamac]

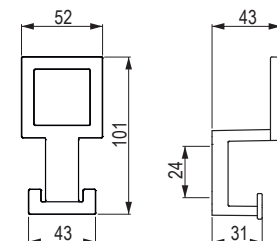

brushed nickel

398005



black matt

398004

Gant [Zn]

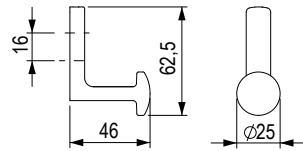

brushed nickel

483282



black matt

483280

Gant XL [Zamac]

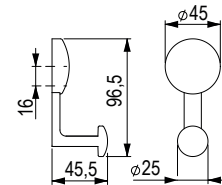

brushed nickel

483285



black matt

483284

Dax [Zamac]

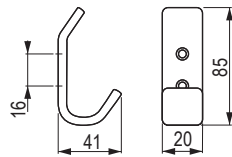

matt chrome

157327



matt nickel

157328

Iwo [Zamac]

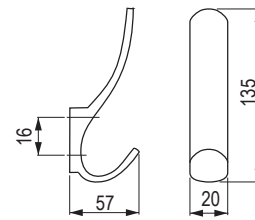

matt nickel

289683



matt chrome

289684

Ener [Zamac]

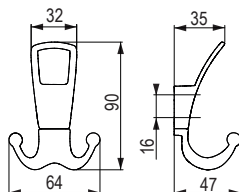

brushed nickel

483276



black matt

483275

Ener XL [Zamac]

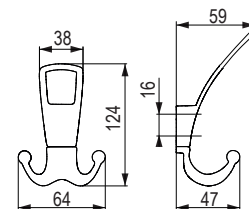

brushed nickel

483274



black matt

483273

hooks

Cid [Zamac]

brushed nickel	black matt
494171	494170

Cid XL [Zamac]

brushed nickel	black matt
494173	494172

Marcel [Zamac]

polished chrome	matt chrome	matt nickel
290153	290154	290155

Marcel XL [Zamac]

polished chrome	matt chrome	matt nickel
290150	290151	290152

Lugo [Zamac]

matt nickel	matt chrome	polished chrome	polished gold	black matt
35591	35592	35593	35594	35595

Lugo XL [Zamac]

matt nickel	matt chrome	polished chrome	polished gold	black matt
35581	35582	35583	35584	35585

Muso [Zn]

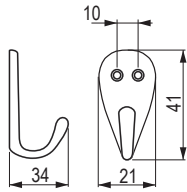

matt chrome

157333



matt nickel

157334



polished chrome

157335



black matt

544823

Lerico [Zn]

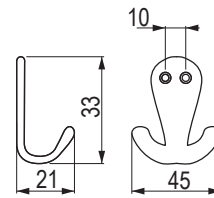

matt chrome

157330



matt nickel

157331



polished chrome

157332



black matt

544824

Livorno [Zamac]

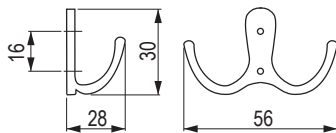

matt nickel

35611



matt chrome

35612



polished chrome

35613



black matt

35615

Rokos [Zamac]

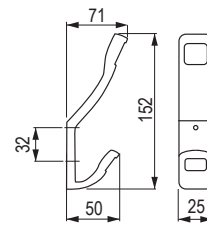

matt nickel

289681



matt chrome

289682

Darec [Zamac]

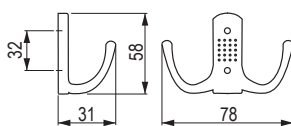

polished chrome

289679



matt chrome

289680

Darec XL [Zamac]

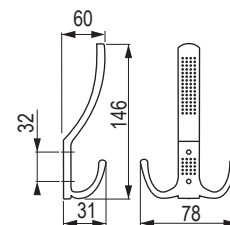

polished chrome

289677



matt chrome

289678

hooks

Murero [Zn]

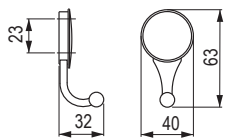

antique gold

157317

Murero XL [Zn]

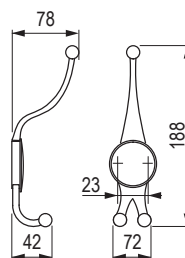

antique gold

157319

Rubico [Zn]

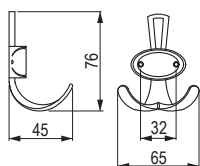

antique black

157309



antique gold

157310

Rubico XL [Zn]

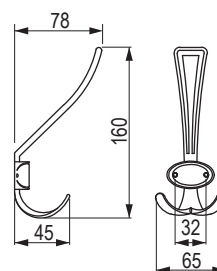

antique black

157311



antique gold

157312

Orio [Zamac]

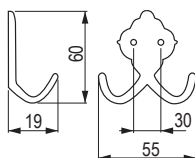

antique gold

36769

Orio XL [Zamac]

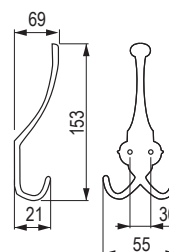

antique gold

36768

Balo XL [Zamac]

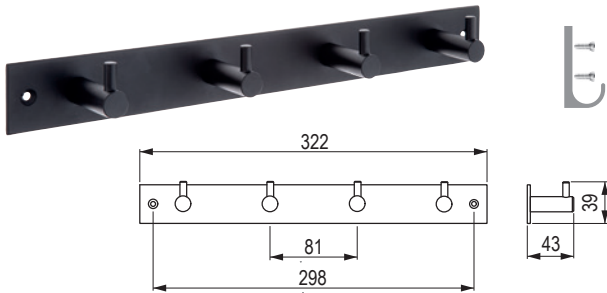

black matt

398939

Twist [Zamac]

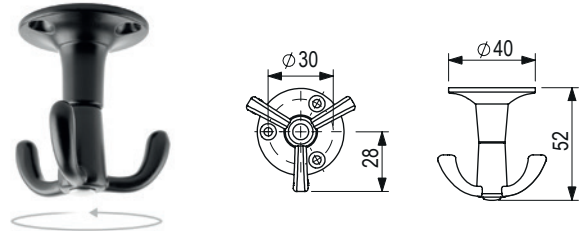

matt chrome

414103



black matt

414102

Xin

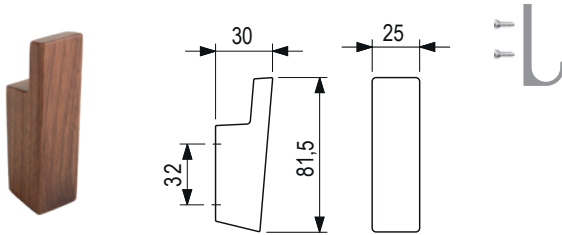

raw oak

500437



lacquered oak

500438



lacquered walnut

500439

Extendo XL [Zamac]

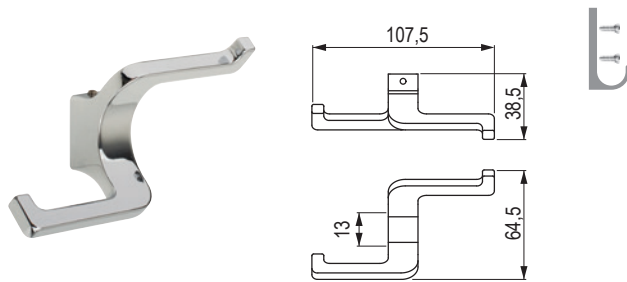

matt chrome

283968



brushed nickel

283969

handles, knobs, hooks

Vitruvio [Zamac]

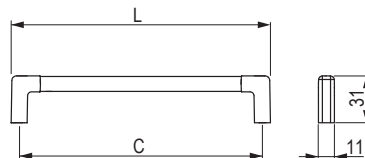

			
anthracite	matt gold	drilling pitch C (mm)	length L (mm)
405059	405061	160	170,6
405060	405062	320	330,6

Lama [Zamac]

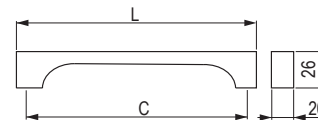

				
matt gold	brown matt	black nickel	drilling pitch C (mm)	length L (mm)
356243	356245	356247	160	170
356242	356244	x	320	330

Tonda [Zamac]

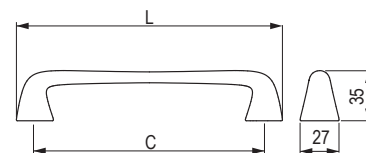

			
black silk touch	grey silk touch	drilling pitch C (mm)	length L (mm)
405046	405050	160	184,4
405047	405051	320	344,4

Torus [Zamac]

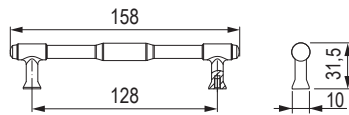

matt gold
541307



black matt
541309

Torus [Zamac]

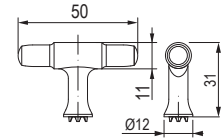

matt gold
541308



black matt
541310

Riva [Zamac]

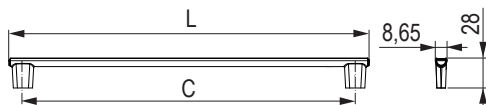

titanium
541315
541316
541318



black matt
541311
541312
541314

drilling pitch
C (mm)

length
L (mm)

160

177

320

337

1088

1110

Riva [Zamac]

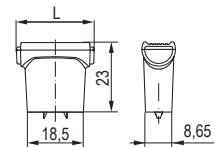

titanium
541317



black matt
541313

length L (mm)

26

Linea [Zamac]

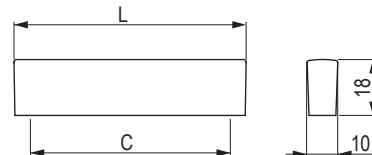

black silk touch

drilling pitch
C (mm)

length
L (mm)

405070	32/64	76
405072	224/256	268

Brera [Zamac]

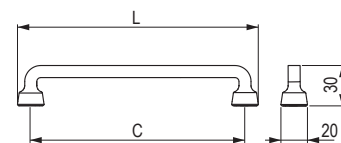

antique bronze



black matt



gold
brushed

drilling pitch
C (mm)

length
L (mm)

356226	356229	405054	96	116
356225	356228	405055	160	180
356224	356227	405056	320	340

Defense [Zamac]

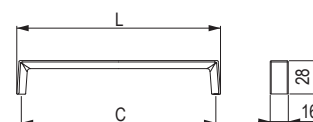

• colour shades may vary



antique gold



black matt

drilling pitch
C (mm)

length
L (mm)

356233	356235	160	167
356232	356234	320	327

Art Decó [Zamac]

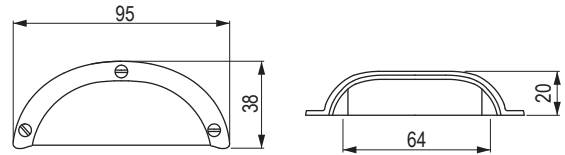

• colour shades may vary



rust effect

356270



blue washed

356271

Viaggio [Zamac]

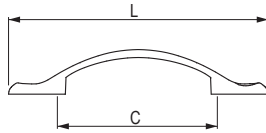
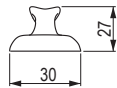

• colour shades may vary



washed Stone

356261



rust effect

356264

drilling pitch
C (mm)

96

length
L (mm)

156

356260

356263

128

187

Viaggio [Zamac]

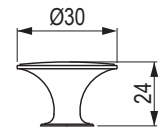

• colour shades may vary



washed Stone

356262



rust effect

356265

Sirius [Zamac]

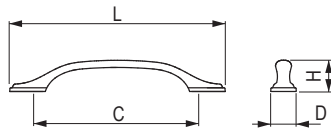

• colour shades may vary



rust effect

356254



antique
pewter

284267

drilling
pitch
C (mm)

96

length
L (mm)

142

width
D (mm)

21

height
H (mm)

28

356253

284268

128

177

22

29

356252

284269

160

210

25

30

handles, knobs, hooks

Columnae [Zamac]

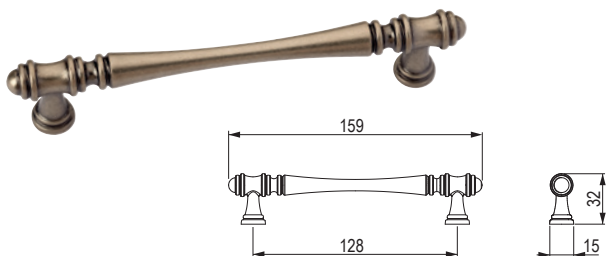

bronze
405063



antique pewter
405064



dark antique copper
405065

Columnae [Zamac]

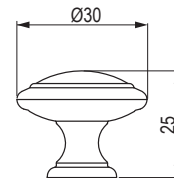

bronze
405066



antique pewter
405067



dark antique copper
405068

Macis [Zamac]

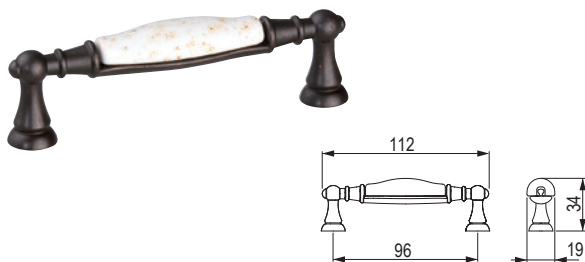

dark antique copper / porcelain white
284279

Macis [Zamac]

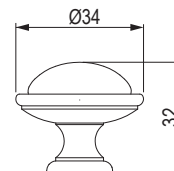

dark antique copper / porcelain white
284280

Augusto [Zamac]

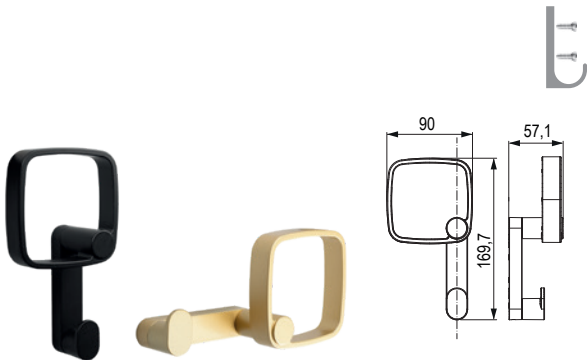

dark matt gold

541305



black matt

541304

Tiberio [Zamac]



black matt

541306

Smarty [Zamac]

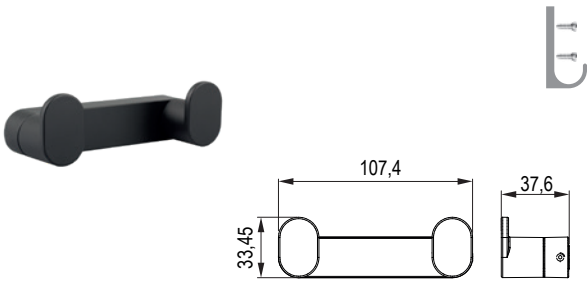

black matt

541301

Jonathan [Zamac]

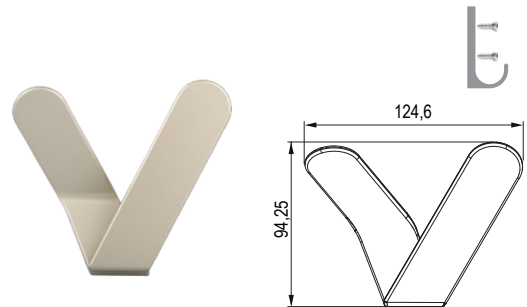

titanium

541302



black matt

541303

Aramis S [Zamac]

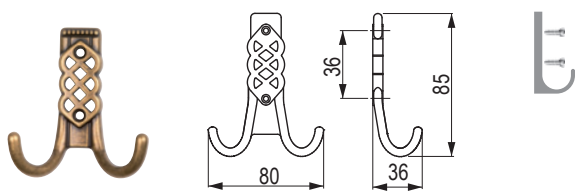

bronze

284271

Aramis M [Zamac]

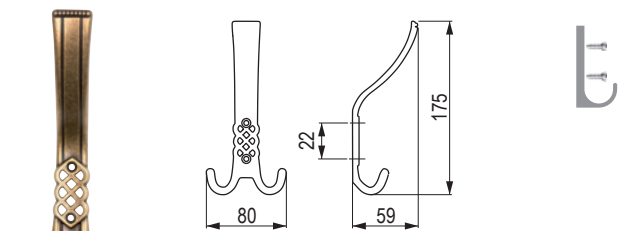



bronze

284273

Florida profiles

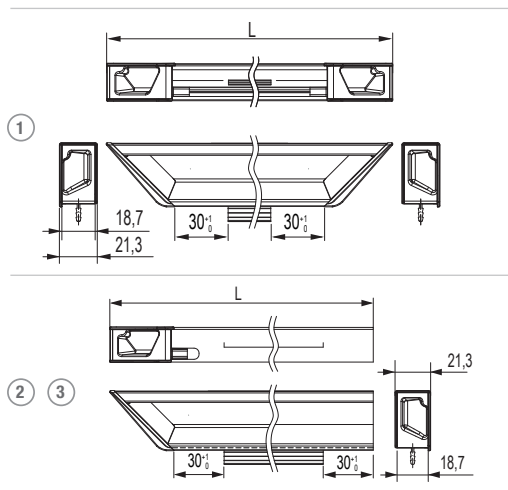
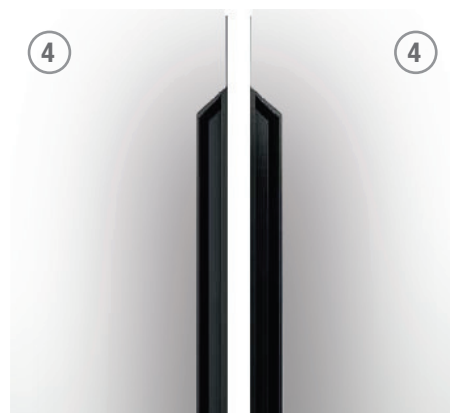
- Option of various combinations of ready-made profile and trimming from a 3 m profile to size.
- A trimmed profile can be finished with 3 types of end caps.
- The profile can be used both vertically and horizontally.
- Combination of profile for hinged doors and doors with slide.



		black matt	length L (mm)	option	door thickness (mm)	height (mm)
1	●	541319	380	central	18	36
2	●	541323	200	left	18	36
		541324	380	left	18	36
3	●	541320	200	right	18	36
		541321	380	right	18	36
4	●	541325	1088	left	18	36
		541322	1088	right	18	36



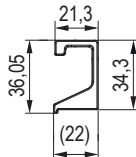

Florida profile

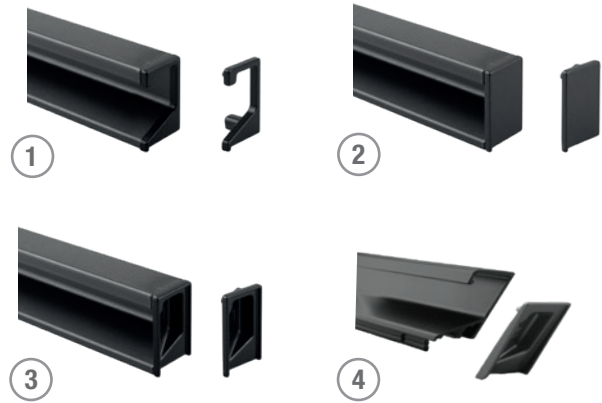

	length L (mm)	door thickness (mm)	height (mm)
black matt			
541326	3000	18	36

End caps for Florida profile



	black matt	option
1	541327	open end cap R+L
2	541328	closed end cap R+L
2	541329	centre end cap R+L
4	550784	straight centre end cap



Anzio

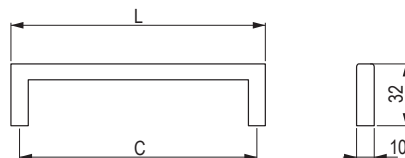

code	Hettich code	surface treatment	drilling pitch C (mm)	length L (mm)
133350	1160018	brushed stainless steel	128	138
135134	1160020	brushed stainless steel	224	234
146741	1160023	brushed stainless steel	288	298
318716	9204177	brushed stainless steel	320	330
133349	1160022	brushed stainless steel	352	362
146742	1160023	brushed stainless steel	480	490

Bermeo

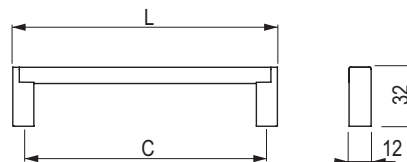

code	Hettich code	surface treatment	drilling pitch C (mm)	length L (mm)
395157	9208083	black matt / stainless steel imitation	160	173
395156	9208087	black matt / stainless steel imitation	288	301

Intra

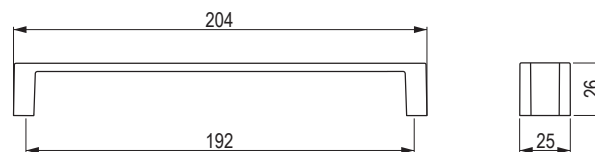

code	Hettich code	surface treatment
153731	9105735	stainless steel imitation / polished chrome
134824	9105737	matt chrome / polished chrome

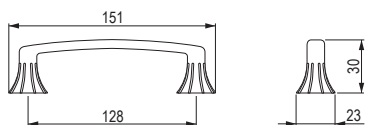
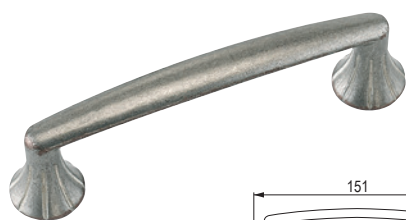
Salacia

code	Hettich code	surface treatment
135768	9112591	pewter

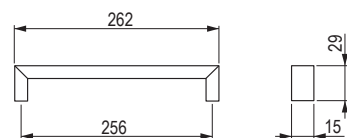
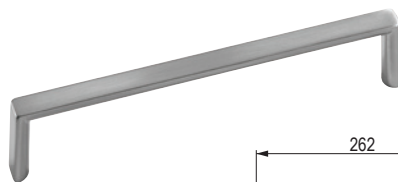
Baldone

code	Hettich code	surface treatment
135846	9995485	stainless steel imitation

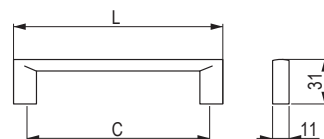
Chalcis

code	Hettich code	surface treatment	drilling pitch C (mm)	length L (mm)
161149	9113183	stainless steel imitation	128	147
154385	9113182	stainless steel imitation	288	301

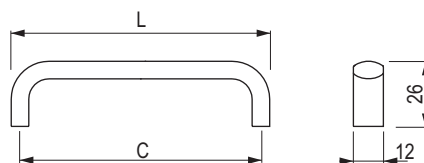
Naila

code	Hettich code	surface treatment	drilling pitch C (mm)	length L (mm)
409634	9266078	black matt	96	103
409635	9266079	black matt	128	135
409636	9266080	black matt	160	167
409637	9266091	black matt	192	199
409638	9266092	black matt	256	263
409640	9266094	black matt	320	327

Catana

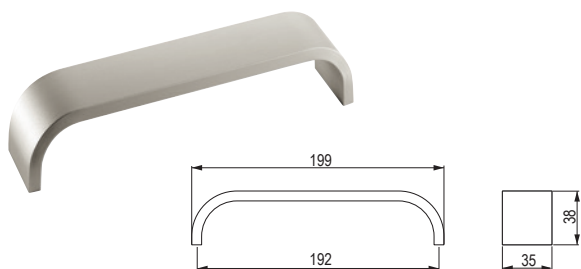

code	Hettich code	surface treatment
106317	115080	stainless steel imitation

Vantania

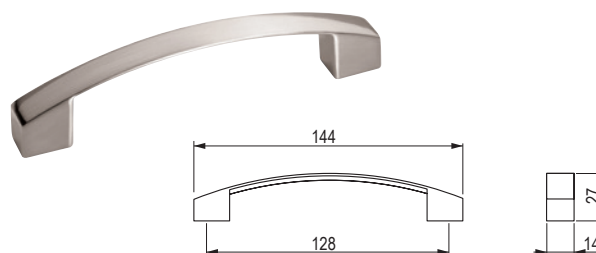

code	Hettich code	surface treatment
134885	1170158	stainless steel imitation
153735	9113211	polished chrome

Salona

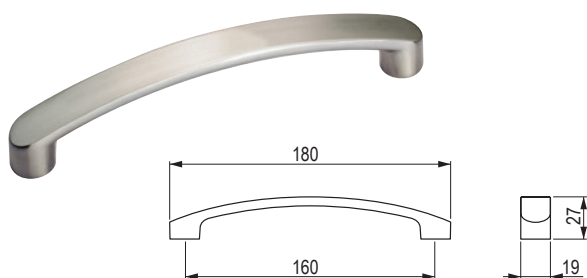

code	Hettich code	surface treatment
141597	1170155	stainless steel imitation

Egara

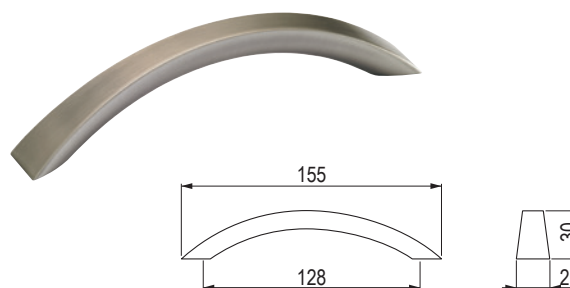

code	Hettich code	surface treatment
106184	9071719	antique gold
106258	9071720	brushed pewter

Balmo

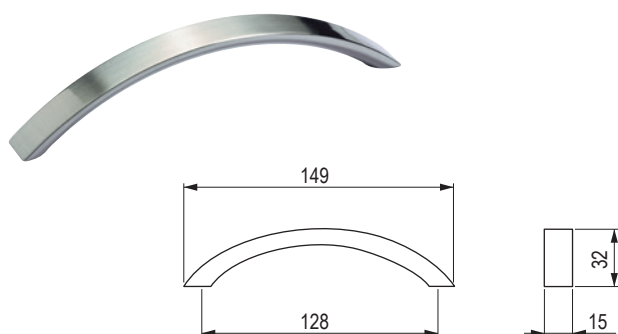

code	Hettich code	surface treatment
107814	43472	stainless steel imitation

Genoa

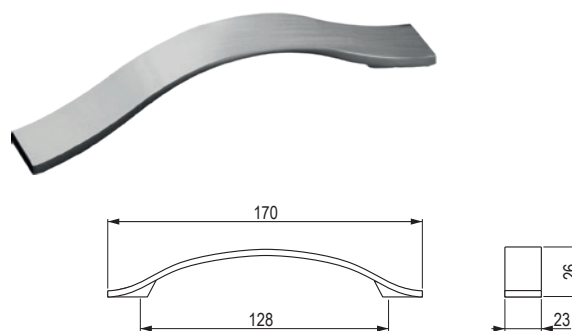

code	Hettich code	surface treatment
106675	9065612	stainless steel imitation

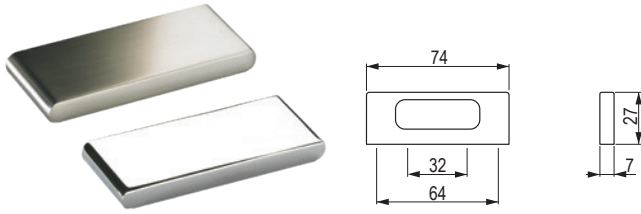
Fermo

code	Hettich code	surface treatment
107413	115020	polished chrome
106987	115019	stainless steel imitation

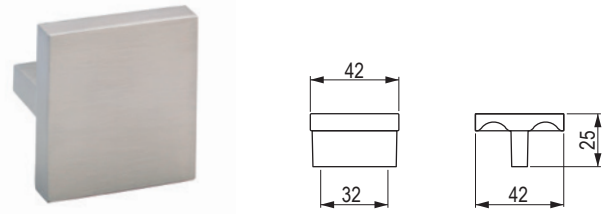
Messana

code	Hettich code	surface treatment
107020	115156	stainless steel imitation

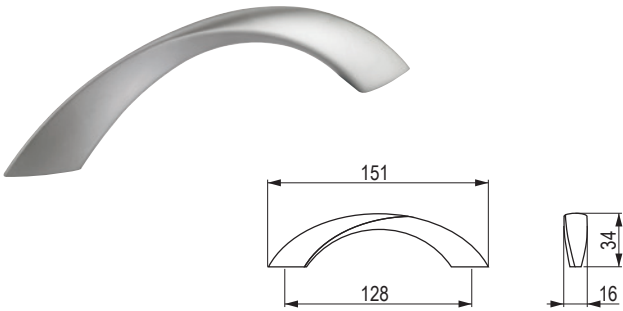
Coria

code	Hettich code	surface treatment
154567	9112597	matt chrome

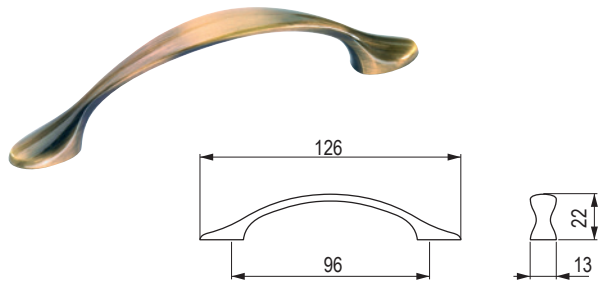
Haida

code	Hettich code	surface treatment
156856	9113227	antique gold

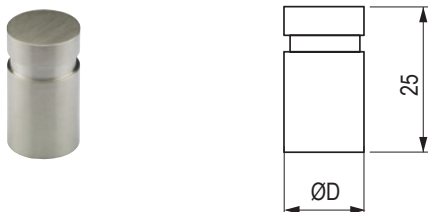
Monacum

code	Hettich code	surface treatment	diameter D (mm)
106762	9070957	brushed stainless steel	10
106562	9070958	brushed stainless steel	14

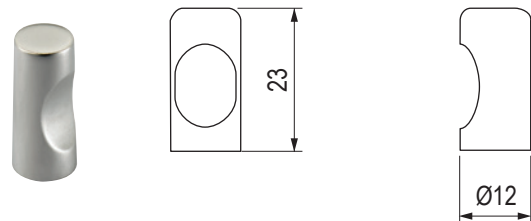
Almus

code	Hettich code	surface treatment
106827	9112583	polished chrome
105387	9112588	matt nickel
153736	9114036	stainless steel imitation

Gela

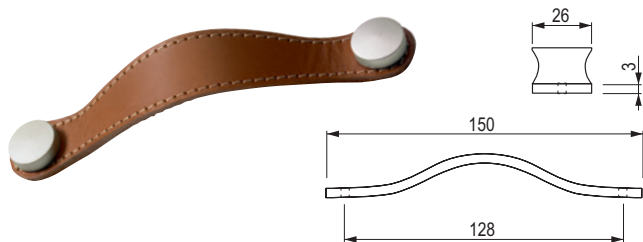

code	Hettich code	surface treatment
182316	9113645	light brown
131687	9113646	dark brown
187687	9113647	black

Galati

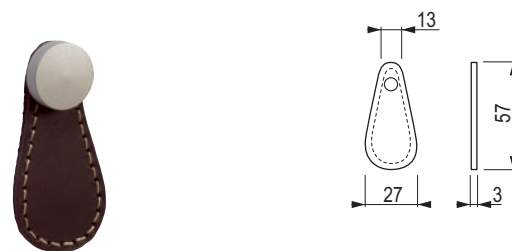

code	Hettich code	surface treatment
409643	9113645	light brown
409644	9113646	dark brown

Clips for Gela and Galati handles



code	Hettich code	surface treatment
376385	9113651	matt chrome
187690	9113653	matt nickel
187691	9113654	antique bronze

Aboa



code	Hettich code	surface treatment
106763	9070138	brushed stainless steel

Empoli

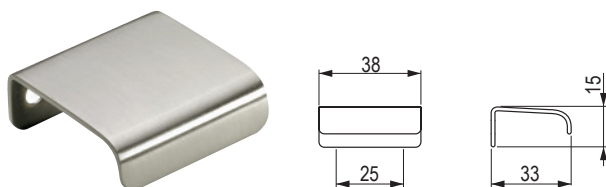

code	Hettich code	surface treatment
131685	9995541	polished chrome
133474	9995540	matt chrome
142100	9995542	stainless steel imitation

Narni

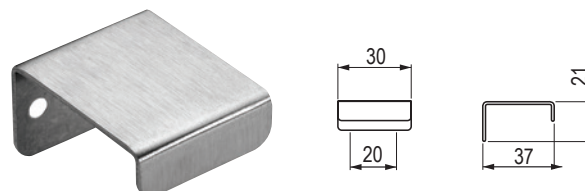

code	Hettich code	surface treatment
134538	9995574	brushed stainless steel

Nidum

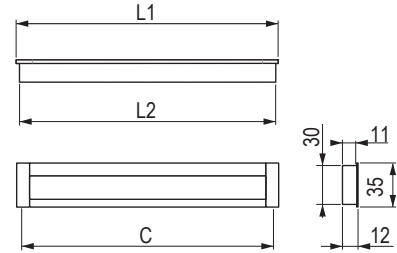

code	Hettich code	surface treatment	drilling pitch C (mm)	length L1 (mm)	length L2 (mm)
106761	9071060	anodised aluminium	96	111	107
105388	9071071	anodised aluminium	128	143	139
107319	9071073	anodised aluminium	160	175	171
106090	9071075	anodised aluminium	192	207	203

Touch - in

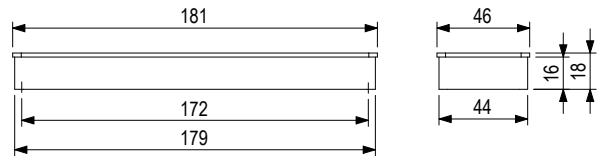

code	Hettich code	surface treatment
105901	9086687	stainless steel imitation

Touch - in



code	Hettich code	description	surface treatment
130326	9086695	cover	non-lacquered plastic
127861	9086696	cover	stainless steel imitation
106193	9086691	handle	stainless steel imitation

- a cover with no surface treatment (ABS plastic) is intended for varnishing
- a cover with a surface treatment is intended for gluing of a veneer or a similar material

Adapter for fixing handles to folding doors



chrome
289675

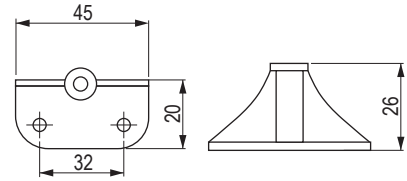

satin nickel
289676

Rubber handle pad for mounting in glass



rubber handle pad
08002

- for proper operation, use 2 pads per one screw
- metal must not lie directly on glass
- transparent, for bolt diameter 4 mm

BlueJig handle hole marking template

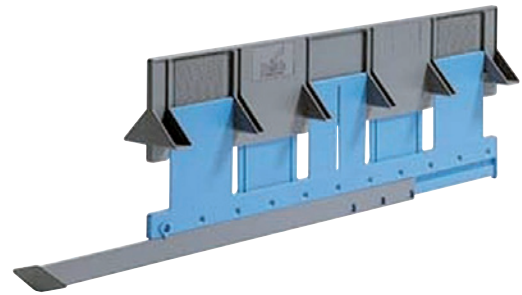

hole marking jigs
104215

- universal BLUEJIG marking template with two-axis adjustment for quick and precise marking the drilling patterns
- designed for handles with a pitch of 32–320 (mm)
- distance range from the side edge of the drawer front to the first mounting hole of the handle is 10–334 (mm)
- distance from the top edge of the brace or from the bottom edge of the brace to the handle 20–65 (mm)

Drilling jig for drilling Tulip handles

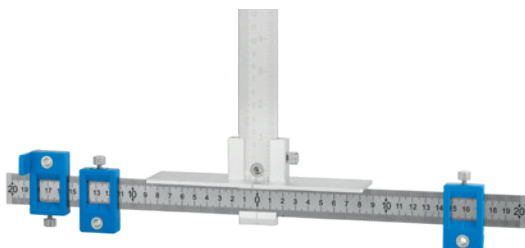

drilling jig
495129

- Tulip drilling jig for designation the position of the holes for the handles
- adjustment in two axes (vertical and horizontal)
- for handles from 16 mm to 480 mm
- material: aluminium, plastic

TULIP

**A handle that will flourish
in any interior**

