



Universal

The new frame for aluminium, glass and wooden doors
Il nuovo telaio per ante in alluminio, vetro e legno

www.ternoscorrevoli.com/universal



Universal

PATENTED

Universal is the innovative Terno Scorrevoli frame, designed for doors in glass, timber and aluminium. Clean lines, reduced encumbrances, high resistance. These are the main features of a product which allows today, thanks to totally renovated design, to meet the market demands of designers and architects.

Universal è l'innovativo telaio di Terno Scorrevoli, realizzato per ante in vetro, legno e alluminio. Linee pulite, ingombri ridotti, massima resistenza: queste le caratteristiche principali di un prodotto che oggi, grazie al design completamente rinnovato, è in grado di rispondere alle richieste del mercato e di progettisti e architetti.





Minimal and linear design

The vertical upright with reduced dimensions will decrease visibility of extruded. Lines will then result linear and clean. The gap, in the upper side of the door as in the bottom, has been reduced to the same of a standard swing door and no additional drilling or milling processes are required. The external cover of track, aligned with the door, will shape a continuous surface. All features contribute to lend the system to an essemptial, but pleasent design.

Design pulito e lineare

Il montante verticale con dimensioni ridotte riduce la visibilità degli estrusi. Le linee risultano così lineari e pulite. La luce, sia nella parte alta che nella parte bassa della porta, è ridotta al pari di una porta battente. Non sono necessarie lavorazioni di foratura e fresatura. La copertura in alluminio e la porta formano una superficie continua: tutto concorre a conferire al nuovo telaio un design essenziale ma piacevole.

“The new UNIVERSAL frame is the perfect answer to the requirements for an elegant, performant and high resistant product”

“Il nuovo telaio UNIVERSAL è la risposta perfetta alle richieste di un prodotto elegante, ma funzionale e resistente”

The highest resistance

Tubular extruded profiles, metal joints, perfect grip, load-bearing connectors, bi-extruded gasket. All components contribute to grant the glass weigth to be sustained by vertical uprights and horizontal crosstracks, halving the pressure of it.

La massima resistenza

Estrusi tubolari, giunzioni in metallo, aderenza massima, attacchi portanti, guarnizione biestrusa: il peso del vetro è sostenuto dai montanti e dai traversi, e ne viene dimezzata la pressione.





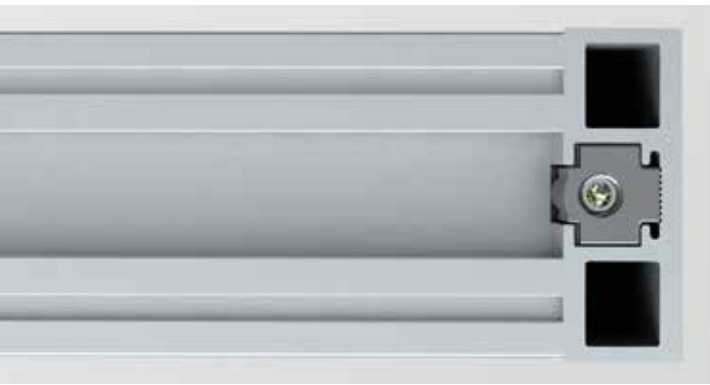

Versatility and resistance

The new frame's extruded profiles are tubular and are assembled by metal joints, without any additional drilling processing requirement. This allows to cut profiles to favourite size, without any drilling or milling process, always granting the perfect grip.

Resistenza e flessibilità

I nuovi estrusi del telaio sono tubolari, per ottenere la massima resistenza, e vengono assemblati tramite giunzione in metallo, senza necessità di lavorazioni di foratura: questo permette di tagliare la barra nella misura preferita, senza fori nè fresate, e di ottenere la massima aderenza.

Extreme versatility of material and configurations

The 45 mm thickness allows to combine fixed aluminium panels to standard sliding wooden doors. New Universal frame basically allows multiple different configurations: from the single sliding door, to the sliding door combined with two or three fixed elements or panels, the double sliding doors with or without additional fixed elements.

Estrema versatilità di materiali e configurazioni

Lo spessore da 45 mm permette di abbinare le ante in alluminio alle porte di legno standard. Le configurazioni che il telaio Universal consente di creare sono molteplici: dall'anta singola scorrevole, all'anta singola abbinata con uno o due elementi fissi, dall'anta doppia scorrevole all'anta doppia abbinata a due elementi fissi.

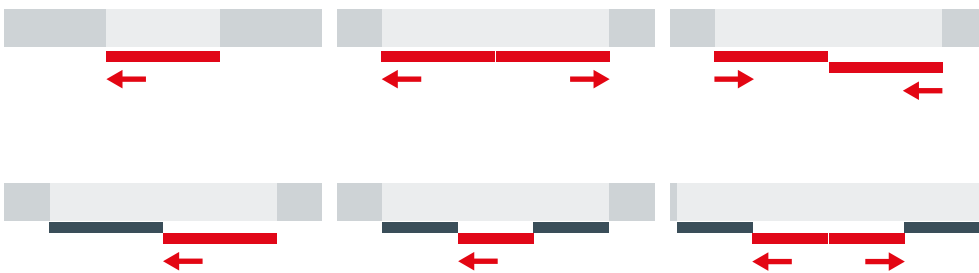

Reduced vertical and horizontal gap

Into the horizontal crosstrack are inserted dustcover brushes, allowing to fill the gap either in the bottom, as in the upper side, towards the external cover. According to that, horizontal or vertical door's gap will result extremely reduced.

Spazio di aria e di luce ridotti

Nel montante orizzontale vengono inseriti gli spazzolini parapolvere, che permettono di chiudere la luce sia nella parte inferiore che nella parte superiore, verso la copertura: lo spazio di aria e di luce risultano così estremamente ridotti.

Essential and modern design

Vertical upright has been designed with reduced dimensions in order to extremely limitate the visual impact of extruded profiles. The external cover of track, aligned with the door, will shape a continuous surface, pleasing to the eye. Profiles and accessories may also be realized in different finishings, from lighter to darker colours, as per latest design trends.

Design essenziale e moderno

Il montante verticale ha dimensioni ridotte per limitare estremamente la visibilità degli estrusi. La copertura in alluminio e la porta formano una superficie continua, piacevole alla vista. I profili e gli accessori possono inoltre essere realizzati con diversi tipi di finiture, dai colori più chiari fino a colorazioni più scure, di tendenza.

Installation in every context

Universal frame may be combined with two of bracket series already existing in Terno Scorrevoli range: **Eclettica** and **Evolution**. In combination with lateral automatic clipping bracket **Eclettica**, the new frame may be fixed on the wall, directly to the ceiling or to counterceiling. The external cover has been designed to be totally aligned to the handle, in order to shape a continuous surface to reduce as much as possible horizontal gap. Instead, combining **Universal** frame to invisible **Evolution** bracket, it is possible to perform any possible installation option, from wall to ceiling fixing, with the benefit of having a complete closure of upper horizontal gap, given that the door will be positioned in the middle of the crawlspace between the two external covers, closing the upper gap at 100% and keeping sliding elements totally hidden.



Installazione in ogni contesto

Il telaio **Universal** si può utilizzare con due staffe già presenti nel catalogo Terno Scorrevoli: la staffa **Eclettica** e la staffa **Evolution**. Combinato con la staffa automatica laterale **Eclettica**, il nuovo telaio può essere installato sia a parete che a soffitto, che a controsoffitto. La copertura in alluminio è stata disegnata per essere allineata completamente alla maniglia, definendo così una superficie unica e continua che riduce al minimo la luce. Combinando invece il telaio **Universal** alla staffa invisibile **Evolution**, si ottengono tutte le soluzioni possibili a parete e a soffitto, con il vantaggio di avere una chiusura totale della luce: la porta si inserisce nell'intercapedine delle due coperture e la luce è così chiusa al 100%, e i meccanismi di scorrimento sono completamente nascosti.

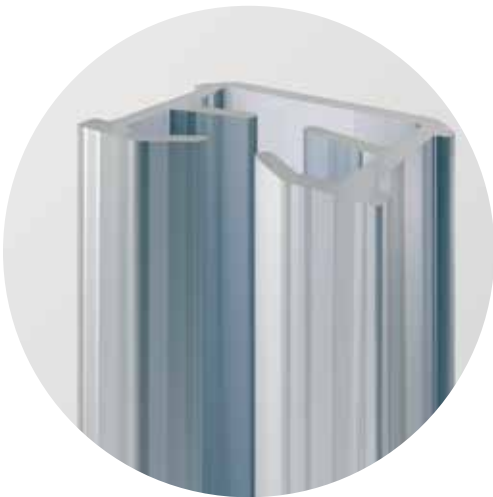

Dedicated to monolithic and laminated glass

Thanks to innovative extruded profiles, **Universal** frame results to be highly resistant. Furthermore, it has been realized an innovative bi-extruded gasket which allows an optimal grip of glass. The bi-extruded gasket will allow to use monolithic and laminated glasses from 5 up to 8,5 mm thickness.

Per vetri monolitici o stratificati

Grazie agli innovativi estrusi, il telaio **Universal** risulta molto resistente. È stata realizzata, inoltre, un'innovativa guarnizione biestrusa che permette un'ottimale tenuta del vetro. Con questa guarnizione, è possibile montare vetri monolitici o laminati con spessori da 5 a 8,5 mm.

Load-bearing crosstracks



The metal joint connector which hold the crosstrack it is not acting only as a divider, but it also has a load-bearing function, in order to uniformly distribute the glass weight along vertical uprights and horizontal crosstracks, halving the pressure of it and allowing to realize larger surfaces.



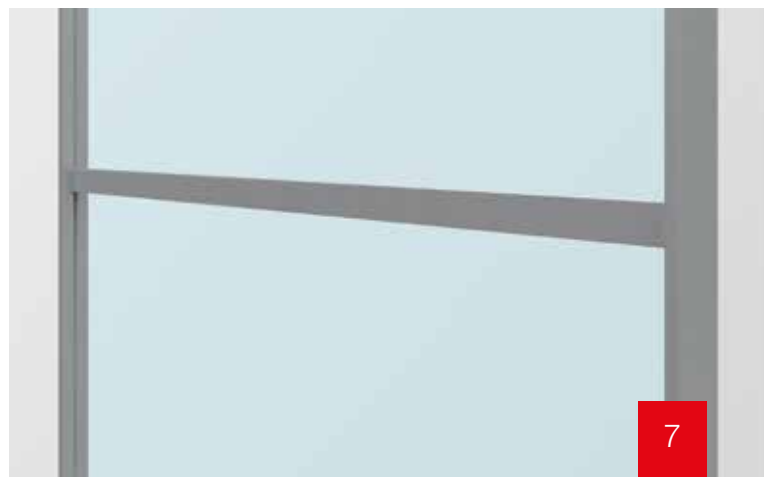



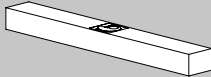

Traversi portanti

L'attacco metallico che sostiene il traverso non funge solo da divisorio, ma è portante: questo vuol dire che il peso del vetro è distribuito uniformemente su montanti e traversi, dimezzandone la pressione, e permettendo di creare superfici più grandi.



Tracks / Binari		ALUMINUM FINISHES CODES / CODICI FINITURE ALLUMINIO			
CODE / CODICE		FINISH COLOR / COLORE FINITURA			
8 01 0.0		01	A	Anodized Silver / Argento	STANDARD
8 02 0.0		02	AS	Brushed Anodized Silver / Argento Spazzolato	
8 13 0.0		13	E3S	Brushed Anodized Dark Brown / E3 Spazzolato	SPECIAL
8 15 0.0		15	NS	Brushed Anodized Black / Nero Spazzolato	
8 17 0.0		17	NKS	Brushed Anodized Nickel / Nichel Spazzolato	

Tracks / Binari		PLASTIC FINISHES CODES / CODICI FINITURE PLASTICA			
CODE / CODICE		FINISH COLOR / COLORE FINITURA			
8 23 0.0		23	GR	Gray / Grigio	STANDARD

Universal		COMPLETE BOX KIT / KIT COMPLETO IN SCATOLA		
K	Complete kit / Kit completo			
0421	 Kit Universal + Evolution (Aluminium / Alluminio)			
0422	 Kit Universal + Evolution (Fix Aluminium Door / Porta fissa in Alluminio)			
0423	 Kit Universal + Eclettica (Aluminium / Alluminio)			
0424	 Kit Universal + Eclettica (Fix Aluminium Door / Porta fissa in Alluminio)			
0425	 Kit Universal + Evolution (Wood / Legno)			
0426	 Kit Universal + Evolution (Fix Wooden Door / Porta fissa in Legno)			
0427	 Kit Universal + Eclettica (Wood / Legno)			
0428	 Kit Universal + Eclettica (Fix Wooden Door / Porta fissa in Legno)			
		0	N.2 Standard stoppers N.2 Fermi standard	
		1	N.2 Fluid dampers N.2 Fermi ammortizzati Fluid Eclettica	
		2	N.2 Fluid dampers N.2 Fermi ammortizzati Fluid Evolution	
		0	Multi measurement Multimisura	
		1	2200x1000 mm	
		2	2600x1200 mm	
		3	3000x1500 mm	
		4	W = 1000 mm	
		5	W = 1200 mm	
		6	W = 1500 mm	
		02	Brushed Anodized Silver Argento Spazzolato	
		13	Brushed Anodized Dark Brown E3 Spazzolato	
		15	Brushed Anodized Black Nero Spazzolato	
		17	Brushed Anodized Nickel Nichel Spazzolato	

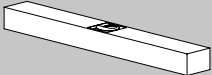
Universal		COMPLETE BOX KIT / KIT COMPLETO IN SCATOLA		
F	Bundle / Fasci			
		0426	Universal + Evolution (Track / Binario)	
		0427	Universal + Eclettica (Track / Binario)	
		5	W – Wall / Parete	
		7	C – Ceiling / Soffitto	
		8	C2 – Ceiling (Double) / Soffitto (Doppio)	
		1	L = 2000 mm	
		2	L = 2400 mm	
		3	L = 3000 mm	
		02	Brushed Anodized Silver / Argento Spazzolato	
		13	Brushed Anodized Dark Brown / E3 Spazzolato	
		15	Brushed Anodized Black / Nero Spazzolato	
		17	Brushed Anodized Nickel / Nichel Spazzolato	

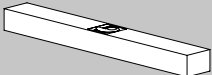
Universal Optional		COMPLETE BOX KIT / KIT COMPLETO IN SCATOLA		
C.0420	Complete handle kit / Kit completo maniglia			
B.0425	Complete load-bearing crosstrack kit / Kit completo traverso portante			
B.0428	Complete adjustable closing jamb kit / Kit completo battuta laterale regolabile			
		A	Accessories / Accessori	
		0	120 mm	
		1	1000 mm	
		2	1200 mm	
		3	1500 mm	
		4	2200 mm	
		5	2600 mm	
		6	3000 mm	
		02	Brushed Anodized Silver / Argento Spazzolato	
		13	Brushed Anodized Dark Brown / E3 Spazzolato	
		15	Brushed Anodized Black / Nero Spazzolato	
		17	Brushed Anodized Nickel / Nichel Spazzolato	

EXAMPLE / ESEMPIO

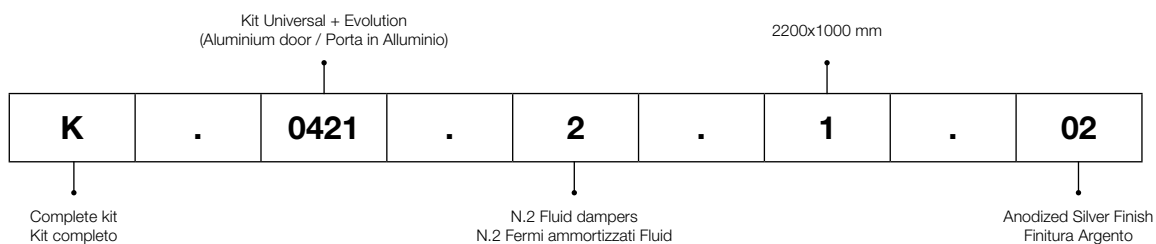

Universal

The new frame for aluminium, glass and wooden doors
Il nuovo telaio per ante in alluminio, vetro e legno

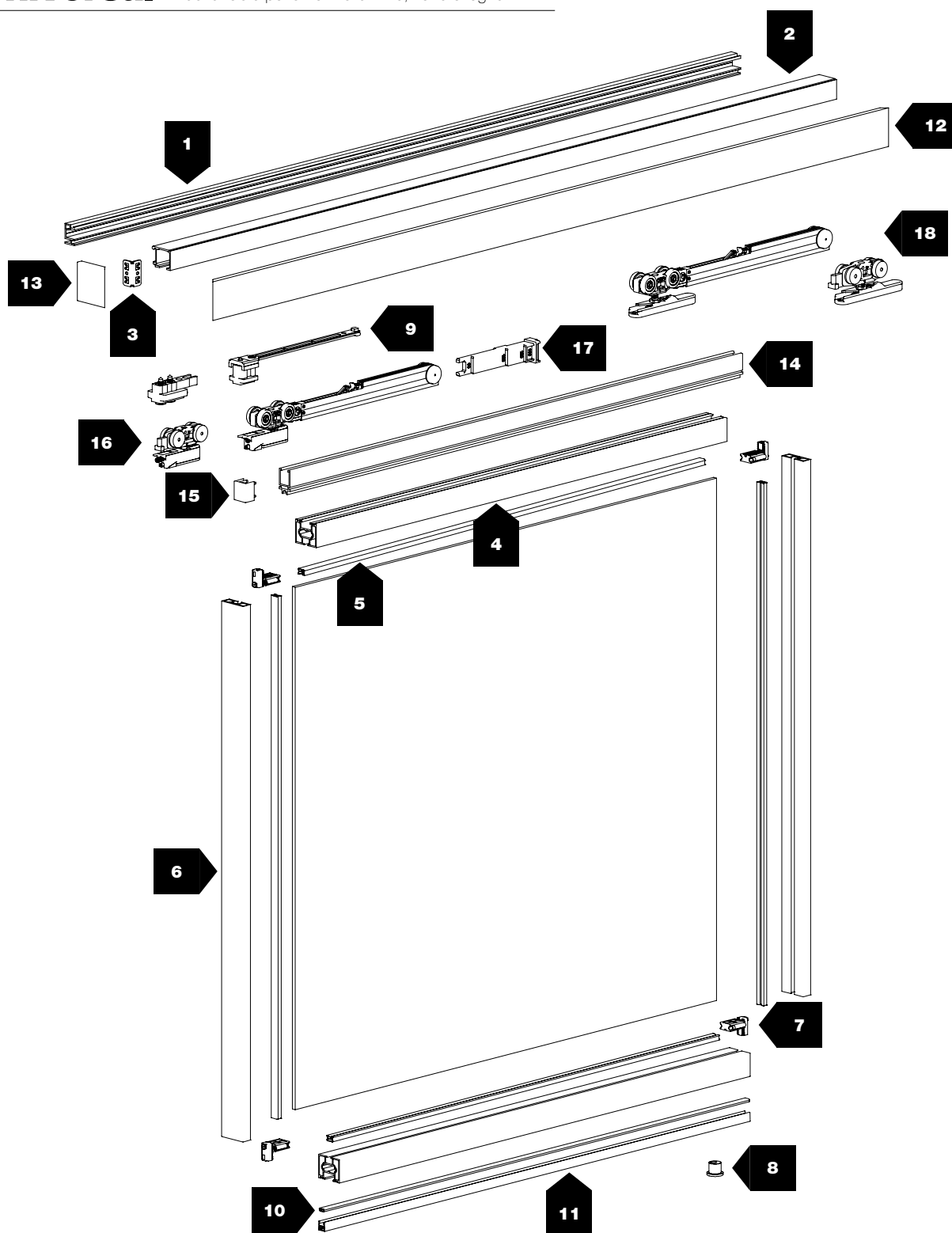

770 mm ÷ 1500 mm



Max 3000 mm



Max 80 kg

COLORS / COLORI



Brushed Anodized
Silver
Argento Spazzolato



Brushed Anodized
Nickel
Nichel Spazzolato



Brushed Anodized
Dark Brown
E3 Spazzolato



Brushed Anodized
Black
Nero Spazzolato

N°	Barcode	Image	kg		N°	Barcode	Image	kg	
1	1710		-		EVOLUTION				
2	1700		-		12	2764		-	
	1280		-		13	2764/2		-	
	1560		-		14	2763		-	
3	2756		-			2753		-	
4	2762		-		15	2767		-	
5	2751		-		16	3362-80		80	FLUD NEW
6	2761		-			2363/T		80	
7	2765		-		17	2353		-	
ECLETTICA									
8	1577		-		12	2755		-	
9	3354		-	FLUD NEW	13	2755/2		-	
	3347		-		18	3382-80_DX		80	FLUD NEW
	84		-			3382-80_SX		80	
10	266		-			83/T		80	
11	1738		-						

Universal

The new frame for aluminium, glass and wooden doors
Il nuovo telaio per ante in alluminio, vetro e legno

EVOLUTION

COMPLETE KIT (FOR ONE SLIDING ALUMINIUM DOOR)
KIT COMPLETO (PER UNA PORTA SCORREVOLE IN ALLUMINIO)

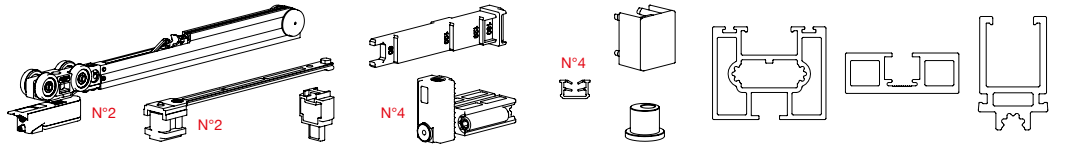

W	H			CODE	COLOURS / COLORI				
					AS	NKS	E3S	NS	
1000 mm	2200 mm	EVOLUTION	80 kg	K.0421.2.1	.02	.17	.13	.15	1x
1200 mm	2600 mm			K.0421.2.2	.02	.17	.13	.15	1x
1500 mm	3000 mm			K.0421.2.3	.02	.17	.13	.15	1x

EVOLUTION

COMPLETE KIT (FOR ONE FIX ALUMINIUM DOOR)
KIT COMPLETO (PER UNA PORTA FISSA IN ALLUMINIO)

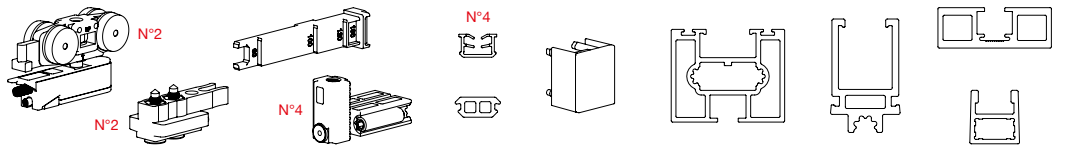
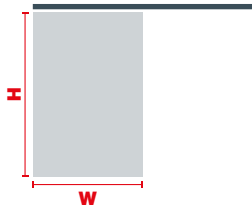

W	H			CODE	COLOURS / COLORI				
					AS	NKS	E3S	NS	
1000 mm	2200 mm	EVOLUTION	80 kg	K.0422.0.1	.02	.17	.13	.15	1x
1200 mm	2600 mm			K.0422.0.2	.02	.17	.13	.15	1x
1500 mm	3000 mm			K.0422.0.3	.02	.17	.13	.15	1x

EVOLUTION

COMPLETE KIT (FOR ONE SLIDING WOODEN DOOR)
KIT COMPLETO (PER UNA PORTA SCORREVOLE IN LEGNO)

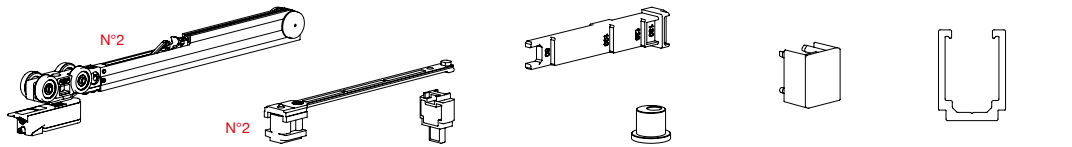

W			CODE	COLOURS / COLORI				
				AS	NKS	E3S	NS	
1000 mm	EVOLUTION	80 kg	K.0425.2.4	.02	.17	.13	.15	1x
1200 mm			K.0425.2.5	.02	.17	.13	.15	1x
1500 mm			K.0425.2.6	.02	.17	.13	.15	1x

EVOLUTION

COMPLETE KIT (FOR ONE FIX WOODEN DOOR)
KIT COMPLETO (PER UNA PORTA IN LEGNO FISSA)

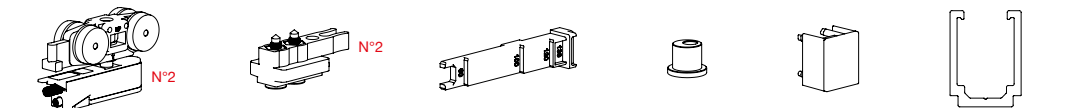

W			CODE	COLOURS / COLORI				
				AS	NKS	E3S	NS	
1000 mm	EVOLUTION	80 kg	K.0426.0.4	.02	.17	.13	.15	1x
1200 mm			K.0426.0.5	.02	.17	.13	.15	1x
1500 mm			K.0426.0.6	.02	.17	.13	.15	1x

TRACKS BY TYPE OF PLACEMENT
BINARI PER TIPOLOGIA DI INSTALLAZIONE

EVOLUTION

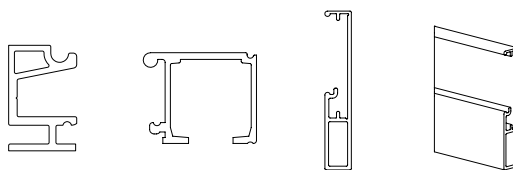

L	PLACEMENT / INSTALLAZIONE	CODE	COLOURS / COLORI				
			AS	NKS	E3S	NS	
2000 mm	WALL / PARETE	F.0426.5.1 <input type="text"/>	.02	.17	.13	.15	1x
2400 mm		F.0426.5.2 <input type="text"/>	.02	.17	.13	.15	1x
3000 mm		F.0426.5.3 <input type="text"/>	.02	.17	.13	.15	1x

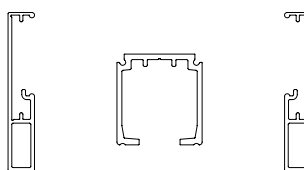

L	PLACEMENT / INSTALLAZIONE	CODE	COLOURS / COLORI				
			AS	NKS	E3S	NS	
2000 mm	CEILING / SOFFITTO	F.0426.7.1 <input type="text"/>	.02	.17	.13	.15	1x
2400 mm		F.0426.7.2 <input type="text"/>	.02	.17	.13	.15	1x
3000 mm		F.0426.7.3 <input type="text"/>	.02	.17	.13	.15	1x

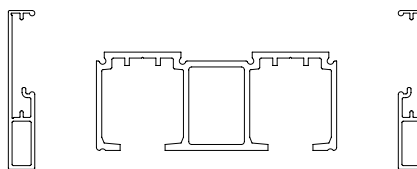

L	PLACEMENT / INSTALLAZIONE	CODE	COLOURS / COLORI				
			AS	NKS	E3S	NS	
2000 mm	CEILING / SOFFITTO	F.0426.8.1 <input type="text"/>	.02	.17	.13	.15	1x
2400 mm		F.0426.8.2 <input type="text"/>	.02	.17	.13	.15	1x
3000 mm		F.0426.8.3 <input type="text"/>	.02	.17	.13	.15	1x

ECLETTICA

COMPLETE KIT (FOR ONE SLIDING ALUMINIUM DOOR)
KIT COMPLETO (PER UNA PORTA SCORREVOLE IN ALLUMINIO)

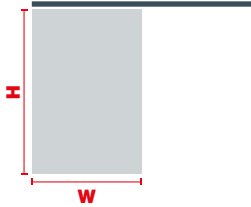
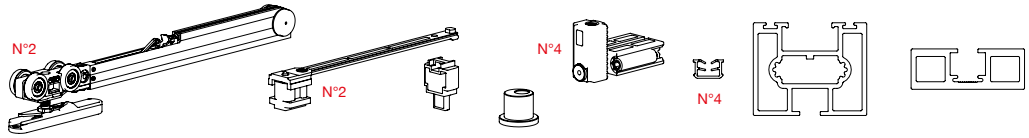
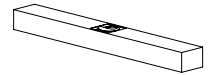

W	H	EYES	PERSON	CODE	COLOURS / COLORI					MIN
					AS	NKS	GRFS	E3S	NS	
1000 mm	2200 mm	ECLETTICA	80 kg	K.0423.1.1	.02	.17	.25	.13	.15	1x
1200 mm	2600 mm			K.0423.1.2	.02	.17	.25	.13	.15	1x
1500 mm	3000 mm			K.0423.1.3	.02	.17	.25	.13	.15	1x

ECLETTICA

COMPLETE KIT (FOR ONE FIX ALUMINIUM DOOR)
KIT COMPLETO (PER UNA PORTA FISSA IN ALLUMINIO)

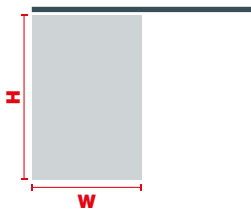
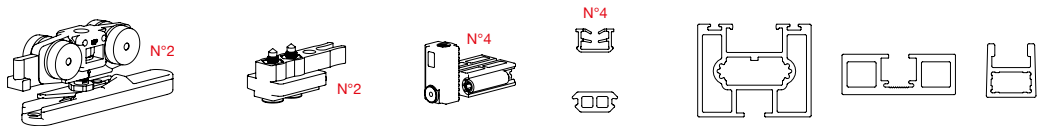
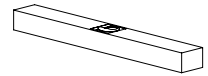

W	H	EYES	PERSON	CODE	COLOURS / COLORI					MIN
					AS	NKS	GRFS	E3S	NS	
1000 mm	2200 mm	ECLETTICA	80 kg	K.0424.0.1	.02	.17	.25	.13	.15	1x
1200 mm	2600 mm			K.0424.0.2	.02	.17	.25	.13	.15	1x
1500 mm	3000 mm			K.0424.0.3	.02	.17	.25	.13	.15	1x

ECLETTICA

COMPLETE KIT (FOR ONE SLIDING WOODEN DOOR)
KIT COMPLETO (PER UNA PORTA IN LEGNO SCORREVOLE)

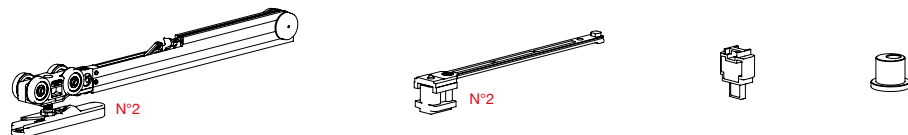
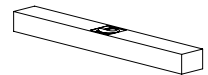

EYES	PERSON	CODE	MIN
ECLETTICA	80 kg	K.0427.1.0	1x

ECLETTICA

COMPLETE KIT (FOR ONE FIX WOODEN DOOR)
KIT COMPLETO (PER UNA PORTA IN LEGNO FISSA)

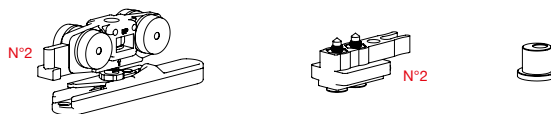
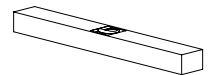

EYES	PERSON	CODE	MIN
ECLETTICA	80 kg	K.0428.0.0	1x

**TRACKS BY TYPE OF PLACEMENT
BINARI PER TIPOLOGIA DI INSTALLAZIONE**

ECCLETTICA

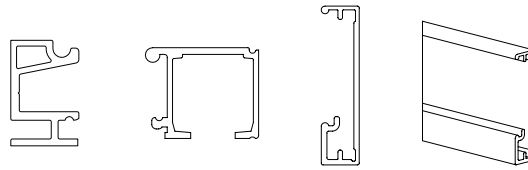

L	PLACEMENT / INSTALLAZIONE	CODE	COLOURS / COLORI					MIN
			AS	NKS	GRFS	E3S	NS	
2000 mm	WALL / PARETE	F.0427.5.1	.02	.17	.25	.13	.15	1x
2400 mm		F.0427.5.2	.02	.17	.25	.13	.15	1x
3000 mm		F.0427.5.3	.02	.17	.25	.13	.15	1x

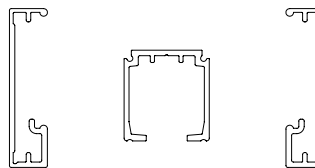

L	PLACEMENT / INSTALLAZIONE	CODE	COLOURS / COLORI					MIN
			AS	NKS	GRFS	E3S	NS	
2000 mm	CEILING / SOFFITTO	F.0427.7.1	.02	.17	.25	.13	.15	1x
2400 mm		F.0427.7.2	.02	.17	.25	.13	.15	1x
3000 mm		F.0427.7.3	.02	.17	.25	.13	.15	1x

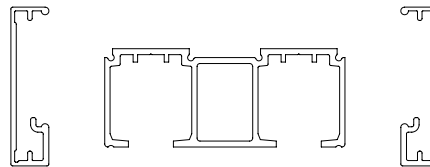

L	PLACEMENT / INSTALLAZIONE	CODE	COLOURS / COLORI					MIN
			AS	NKS	GRFS	E3S	NS	
2000 mm	CEILING / SOFFITTO	F.0427.8.1	.02	.17	.25	.13	.15	1x
2400 mm		F.0427.8.2	.02	.17	.25	.13	.15	1x
3000 mm		F.0427.8.3	.02	.17	.25	.13	.15	1x

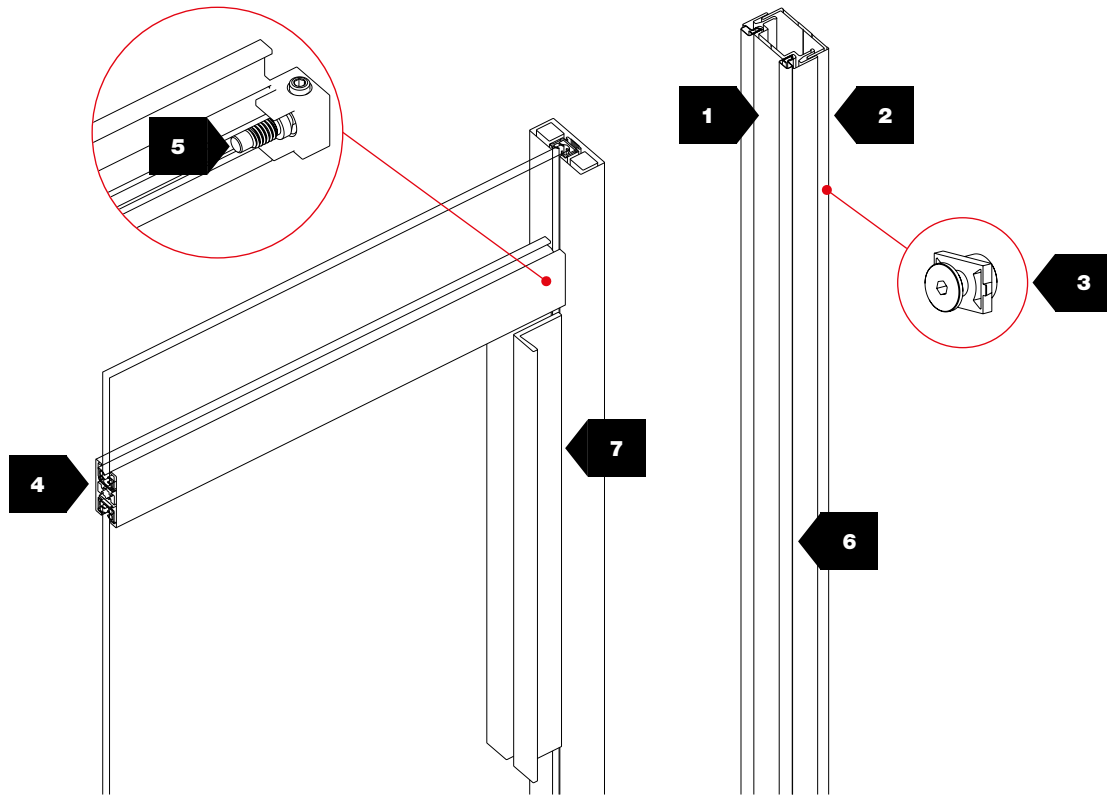

ADJUSTABLE CLOSING JAMB
BATTUTA LATERALE REGOLABILE

CROSSTRACK
TRAVERSO

HANDLE
MANIGLIA

OPTIONAL
+

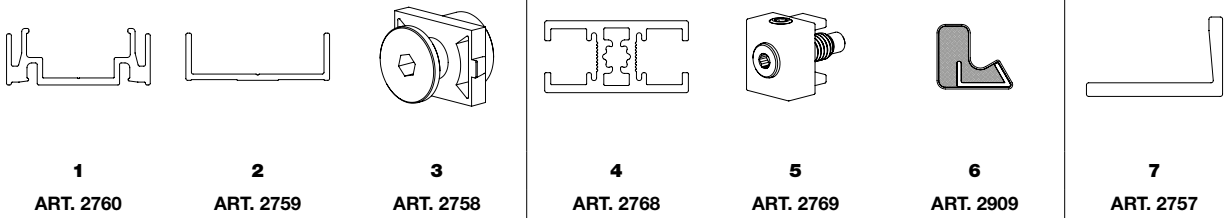

COMPLETE KIT (FOR DOOR HANDLE)
KIT COMPLETO (PER MANIGLIA)

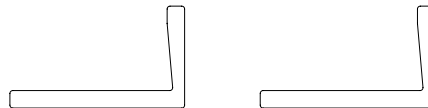

OPTIONAL
+

CODE	COLOURS / COLORI					MIN
	AS	NKS	GRFS	E3S	NS	
C.0420.A.0 <input type="text"/>	<input type="text" value=".02"/>	<input type="text" value=".17"/>	<input type="text" value=".25"/>	<input type="text" value=".13"/>	<input type="text" value=".15"/>	-

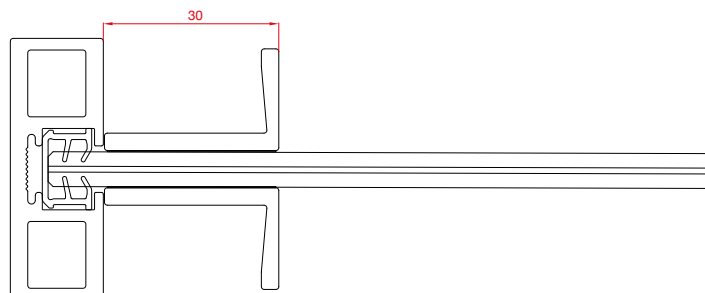

COMPLETE KIT (FOR LOAD-BEARING CROSSTRACKS)
KIT COMPLETO (PER UN TRAVERSO PORTANTE)

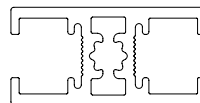
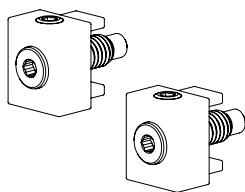

W		CODE	COLOURS / COLORI					
			AS	NKS	GRFS	E3S	NS	
1000 mm	80 kg	B.0425.A.1	.02	.17	.25	.13	.15	—
1200 mm		B.0425.A.2	.02	.17	.25	.13	.15	—
1500 mm		B.0425.A.3	.02	.17	.25	.13	.15	—

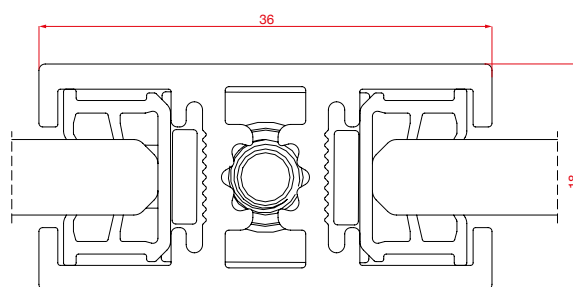

COMPLETE KIT (FOR ONE ADJUSTABLE CLOSING JAMB)
KIT COMPLETO (PER UNA BATTUTA LATERALE REGOLABILE)

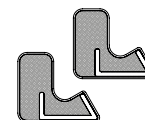
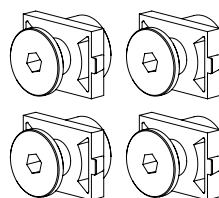
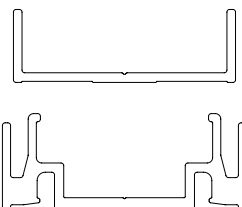

H		CODE	COLOURS / COLORI					
			AS	NKS	GRFS	E3S	NS	
2200 mm	80 kg	B.0428.A.4	.02	.17	.25	.13	.15	—
2600 mm		B.0428.A.5	.02	.17	.25	.13	.15	—
3000 mm		B.0428.A.6	.02	.17	.25	.13	.15	—

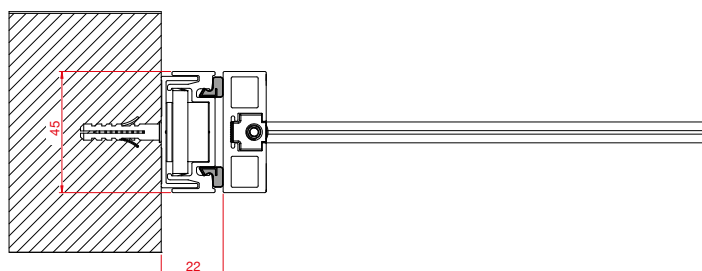

MEASUREMENTS DESCRIPTION / DESCRIZIONI MISURE

ECLETTICA

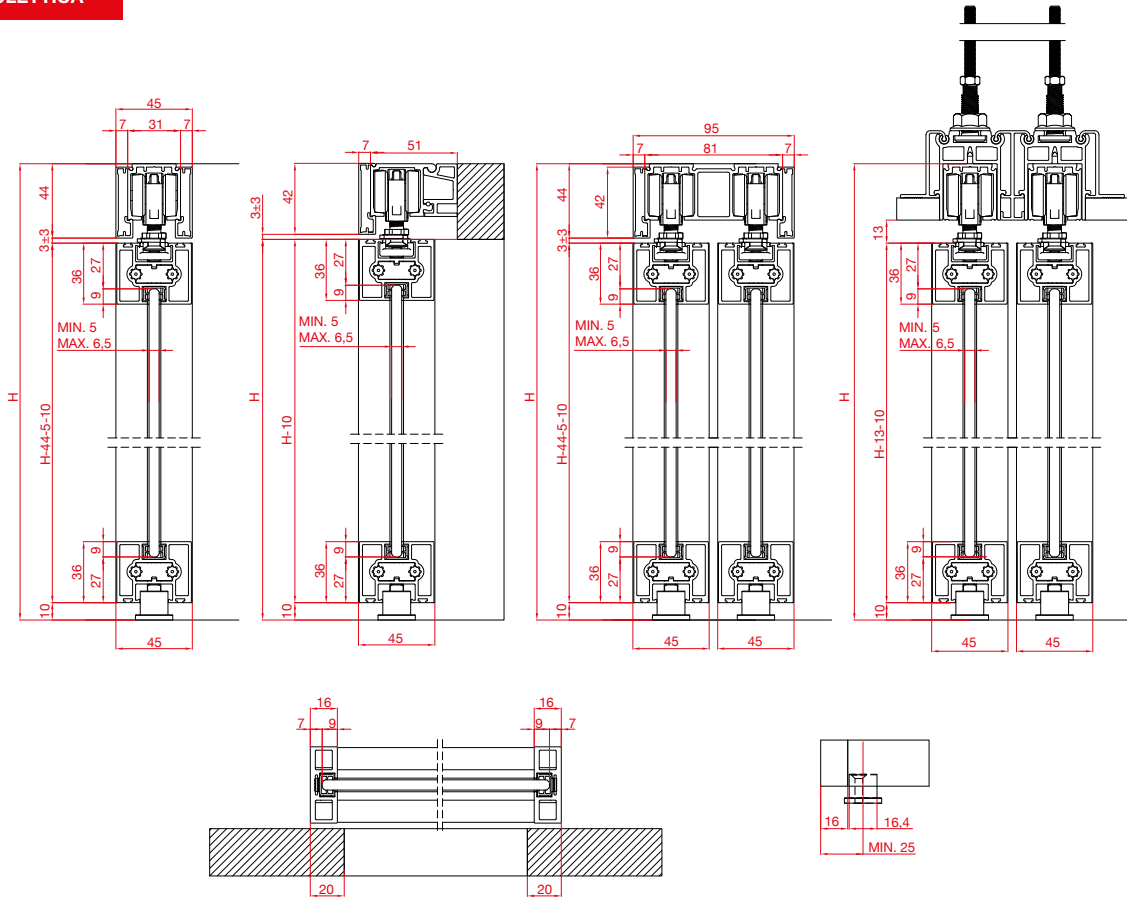

EVOLUTION

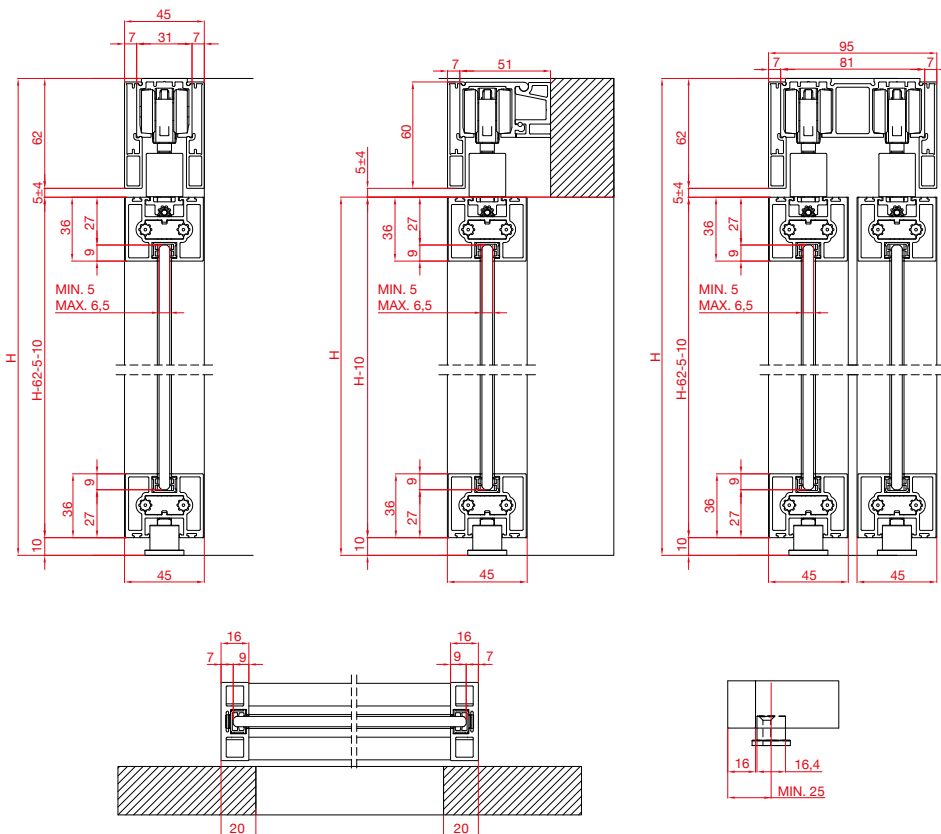



Terno Scorrevoli S.p.A.

**Via Ravenna, 4 - 20814 Varedo (MB) ITALY
Phone +39 0362 543001 - Fax +39 0362 582290**

**terno@ternoscorrevoli.com
www.ternoscorrevoli.com**